



880TM Series

Owner's Manual

Rev B

Aspen[®]

Optima[®]

Cameo[®]

Marin[®]

Altamar[®]

VistamarTM

Capri[®]

Sundance Spas

Attention New Hot Tub Owner!

Congratulations on the purchase of your new Sundance® Spas hot tub! The following is a list of automated functions performed by your hot tub. These functions are listed below in an attempt to suppress any operational concerns you may have during the first 24 hours of ownership! Also listed below are important maintenance recommendations you should observe on a regular basis to protect your new investment.

Maintain Healthy Spa Water

Always maintain your hot tub's water chemistry within the following parameters:

	With CLEARRAY®	Without CLEARRAY®
pH	7.4-7.6	7.4-7.6
Free chlorine	no less than 1.0 ppm	3.0-4.0 ppm
Free Bromine	no less than 2.0 ppm	2.0-4.0 ppm
Total Alkalinity	100-150 ppm	100-150 ppm
Calcium Hardness	150-250 ppm	150-250 ppm

IMPORTANT: CLEARRAY Active Oxygen™ system is factory installed. If the CLEARRAY Active Oxygen™ system is altered or is not operating efficiently then follow the “without CLEARRAY®” water chemistry parameters as defined by the Pool & Hot Tub Alliance. CLEARRAY® Unit requires an annual bulb replacement to operate properly.

 **TO DECREASE RISK OF INFECTION OR DISEASE!** Always maintain your spa filter as outlined below to ensure healthy spa water. Refer to pages 68-70 for additional information.

Required Filter Maintenance

Your new hot tub is equipped with an advanced MicroClean® Ultra II water filtration system that provides unsurpassed water quality! To always ensure maximum water quality, you should replace the filter cartridge every six months, or earlier as necessary. The filter cartridge is designed to be thrown away! Attempts to reuse the filter cartridge may result in the re-release of unwanted particles back into the hot tub. See pages 68-70 for detailed filter cartridge replacement instructions.

Required Water Replacement

 **TO DECREASE RISK OF INFECTION OR DISEASE!** You should replace the hot tub's water every 3 to 6 months. The frequency depends on a number of variables including frequency of use, number of users, and attention paid to water quality maintenance. You will know it is time for a change when you cannot control sudsing and/or you can no longer get the normal feel or sparkle to the water, even though the key water balance measurements are all within the proper parameters. See pages 75-76 for additional information.

Table of Contents

1.0	Important Hot Tub Owner Information	1
2.0	FCC Notice	1
3.0	Important Safety Instructions for all Spa Owners	2
3.1	Entrapment Risk	6
3.2	Hyperthermia	7
3.3	Important Additional Safety Instructions.....	8
3.4	PRECAUTIONS-Important Chemical Safety	8
3.5	PRECAUTIONS FOR USE OF PRODUCTS CONTAINING SODIUM BROMIDE	8
4.0	Locating Your Sundance Hot Tub	9
4.1	Outdoor Location	10
4.2	Indoor Location	10
5.0	General Electrical Safety Instructions	11
6.0	Electrical Installation Instructions (240V Service)	12
7.0	Power Requirements	16
8.0	Hot Tub Fill Up Procedure	16
9.0	Hot Tub Features	22
9.1	Aspen® Hot Tub Features	22
9.2	Aspen Massage/Waterfall Selector Diagram	23
9.3	Aspen Air Controls Diagram.....	24
9.4	Optima® Hot Tub Features.....	25
9.5	Optima Massage/Waterfall Selector Diagram	26
9.6	Optima Air Controls Diagram	27
9.7	Cameo® Hot Tub Features	28
9.8	Cameo Massage/Waterfall Selector Diagram	29
9.9	Cameo Air Controls Diagram	30
9.10	Altamar® Hot Tub Features	31
9.11	Altamar Massage/Waterfall Selector Diagram	32
9.12	Altamar Air Controls Diagram	33
9.13	Vistamar® Hot Tub Features	34
9.14	Vistamar Massage/Waterfall Selector Diagram	35
9.15	Vistamar Air Controls Diagram.....	36
9.16	Marin® Hot Tub Features	37
9.17	Marin Massage/Waterfall Selector Diagram	38
9.18	Marin Air Controls Diagram.....	39
9.19	Capri® Hot Tub Features.....	40
9.20	Capri Massage/Waterfall Selector Diagram	41
9.21	Capri Air Controls Diagram	42
10.0	Registration and Start-up	43
10.1	Start-up Sequence	43
10.2	Register Your New Spa.....	43
10.3	iTouch™ Control Panel Main Menu	44

11.0	Operating Instructions	46
11.1	Activating the Jets Pumps and Blower.....	46
11.2	Lights Menu	47
11.3	Music Menu.....	48
11.4	Connecting the BLUEWAVE® System with your Bluetooth® device.....	49
11.5	Audio Settings.....	50
11.6	CLEARRAY on Demand	50
11.7	Ozone Operation	50
11.8	Selecting The Desired Massage Action	51
11.9	Adjusting Fluidix Reflex™, Nex™, ST™, Intelli-Jet™ and Focus-Relief®	51
11.10	Air Controls	52
11.11	Waterfall Control	52
11.12	Fragrance Dispenser	52
11.13	MicroClean® Plus Versatile Filter Lid	53
11.14	Optional SmartTub® System	53
12.0	Programming and Operation Instructions	55
12.1	Programming the Heat Settings.....	56
12.2	Programming the Primary Filter.....	57
12.3	Programming the Secondary Filter	58
12.4	Cleanup Cycle.....	59
12.5	Programming the Time and Date.....	60
12.6	Water Care Programming	61
12.7	Locking the Spa	64
12.8	Unit Display.....	65
12.9	Programming the Language	66
12.10	Programming the Panel	66
12.11	Diagnostic Information	67
13.0	Hot Tub Maintenance.....	68
13.1	Cleaning/Replacing the Filter Cartridge.....	68
13.2	Removing the Cabinet Panels	70
13.3	Draining And Refilling.....	71
13.4	Cleaning The Hot Tub Interior.....	72
13.5	Pillow Care.....	72
13.6	Maintaining the Hot Tub Cabinet.....	72
13.7	Cover Care And Maintenance.....	72
13.8	Winterizing	73
13.9	Restarting Your Hot Tub in Cold Weather.....	74

14.0	Water Quality Maintenance	75
14.1	pH Control	75
14.2	Sanitizing	75
14.3	CLEARARRAY Active Oxygen™ System	76
14.4	CLEARARRAY® Bulb Replacement and Quartz Tube Maintenance	77
14.5	Other Additives.....	79
14.6	Stainless Steel Handrail Maintenance (if equipped)	79
15.0	Troubleshooting - Display Messages	80
16.0	Troubleshooting - Procedures	83
17.0	Typical Hot Tub Wiring Diagrams A-B (North American 60 Hz Models Only)	85
18.0	North American 60 Hz Electrical Wiring Diagram	86
18.1	North American 60 Hz Models Electrical Wiring Diagram.....	86
18.2	Dip Switch Settings	87

1.0 Important Hot Tub Owner Information

Your Sundance® hot tub is constructed to the highest standards and is capable of providing many years of trouble-free use. However, because heat retentive materials are utilized to insulate the hot tub for efficient operation, an uncovered hot tub surface and wall fittings directly exposed to sunlight and high temperatures for an extended period are subject to permanent damage or discoloration. Damage caused by exposing the hot tub to this abuse is not covered under warranty. We recommend that you always keep the hot tub full of water when it is exposed to direct sunlight and that you keep the Sundance insulating cover in place at all times when the hot tub is not in use. Read and carefully follow the requirements for your hot tub's support base found in the Section 4.0 titled, "Locating Your Sundance Hot Tub" (page 9) or as prescribed by your authorized Sundance Spas dealer.

Sundance hot tubs constantly strives to offer the finest hot tubs available, therefore, modifications and enhancements may be made which affect the specifications, illustrations and/or instructions contained herein.

2.0 FCC Notice

This equipment has been tested and found to comply with the limits for a Class B Digital Device, pursuant to Part 15 of the FCC Rules. These limits are designed to provide reasonable protection against harmful interference in a residential installation. This equipment generates, uses and can radiate radio frequency energy and, if not installed and used in accordance with the instructions, may cause harmful interference to radio communications. However, there is no guarantee that interference will not occur in a particular installation. If this equipment does cause harmful interference to radio or television reception, which can be determined by turning the equipment off and on, the user is encouraged to try to correct the interference by one or more of the following measures:

1. Rearrange or relocate the receiving antenna;
2. Increase the separation between the equipment and receiver;
3. Connect the equipment into an outlet on a circuit different from the circuit connected;
4. Consult the dealer or an experienced radio/TV technician for help. (Changes or modifications not expressly approved by the party responsible for FCC compliance could void the user's authority to operate this equipment).

3.0 Important Safety Instructions for all Spa Owners



READ AND FOLLOW ALL INSTRUCTIONS CAREFULLY!



This spa was manufactured to meet the standards and specifications outlined in the “Virginia Graeme Baker Pool and Spa Safety Act” (VGB Safety Act). Visit www.nspf.org for more information. When installing and using this spa, basic safety precautions should always be followed, including:



1.  **DANGER: RISK OF SEVERE INJURY OR DROWNING!**
 - Extreme caution must be exercised to prevent unauthorized access by children.
 - To avoid accidents, ensure that children do not use this spa unless supervised at all times. Adult supervision is a critical safety factor in preventing children from drowning.
 - Use the straps and clip tie downs to secure the spa cover when not in use. This will help discourage unsupervised children from entering the spa. Keep the spa cover secure in high-wind conditions.
 - There is no representation that the cover, clip tie-downs, or actual locks will prevent access to the spa.

2.  **DANGER: RISK OF SEVERE INJURY OR DROWNING!**
 - Keep hair, loose articles of clothing or hanging jewelry away from suction fittings, rotating jets or other moving components to avoid entrapment that could lead to drowning or severe injury.
 - Never use the spa unless all suction guards, filter, filter lid, or skimmer assembly are installed to prevent body and/or hair entrapment.
 - Never operate or use the spa if the filter, filter lid, or skimmer assembly are broken or any part of the skimmer assembly is missing. Please contact your dealer or nearest service center for service.
 - The suction fittings and suction covers in this spa are sized to match the specific water flow created by the pump(s). If it is necessary to replace the suction fittings, suction covers or pump(s), be sure that the flow rates are compatible and are in compliance with the VGB Safety Act.
 - Never replace a suction fitting or suction cover with one rated less than the flow rate marked on the original suction fitting. Using improper suction fittings or suction covers can create a body or hair suction entrapment hazard that may lead to drowning or severe injury.

3.  **DANGER: RISK OF SEVERE INJURY FROM ELECTRIC SHOCK OR DEATH FROM ELECTROCUTION!**
 - Install the spa at least 5 feet (1.5m), from all metal surfaces. As an alternative, a spa may be installed within 5 feet of metal surfaces if each metal surface is permanently connected (bonded) by a minimum No. 8 AWG (8.4 mm²) solid copper conductor attached to the wire connector on the grounding lug, inside the equipment compartment on the equipment box.

- A grounding wire connector is provided on this unit to connect a minimum No. 8 AWG (8.4 mm²) solid copper conductor between this unit and any metal equipment, metal enclosures of electrical equipment, metal water pipe, or conduit within 5 feet (1.5m) of the unit.
 - Never permit any electrical appliance, such as a light, telephone, radio, television, etc. within 5 feet (1.5m) of a spa unless such appliances are built-in by the manufacturer.
 - Never bring any electrical appliances into or near the spa.
 - Never operate any electrical appliances from inside the spa or when you are wet.
 - The electrical supply for this product must include a suitably rated switch or circuit breaker to open all ungrounded supply conductors to comply with Article 422.20 of the National Electrical Code/ USA, ANSI/NFPA 70. The disconnecting means must be readily accessible and visible to the spa occupant but installed at least 5 feet (1.5m), from the spa.
 - The electrical circuit supplied for the hot tub must include a suitable ground fault circuit interrupter (GFCI) as required by NEC Article 680.42.
4.  **WARNING: RISK OF SEVERE INJURY OR DEATH!**
- Extreme caution must be exercised to prevent diving or jumping into the spa or slipping and falling, which could result in unconsciousness, drowning, or serious injury. Remember that wet surfaces can be very slippery.
 - Never stand, walk or sit on the top railing of the spa.
5.  **WARNING: RISK OF HYPERTHERMIA (OVER-HEATING) CAUSING SEVERE INJURY, BURNS, WELTS OR DEATH!**
- Water temperature in excess of 104°F (40°C) may be injurious to your health.
 - Refer to Section 3.2 Hyperthermia for specific causes and symptoms of this condition.
 - The water in the spa should never exceed 104°F (40°C). Water temperatures between 100°F (38°C) and 104°F (40°C) are considered safe for a healthy adult.
 - Lower water temperatures are recommended for young children (children are especially sensitive to hot water) and when spa use may exceed 10 minutes.
 - The Consumer Products Safety Commission/USA has stated that the water temperature in a spa should not exceed 104°F (40°C).
 - Always test the spa water temperature before entering the spa. The user should measure the water temperature with an accurate thermometer since the tolerance of water temperature-regulating devices may vary as much as +/- 5°F (2°C).

6.  **WARNING: RISK OF SEVERE INJURY OR DEATH!**
- Since excessive water temperatures have a high potential for causing fetal damage during the early months of pregnancy, if pregnant or possibly pregnant, consult your physician before using a spa.
 - Pregnant or possibly pregnant women should limit spa water temperatures to 100°F (38°C).
 - Persons suffering from obesity or a medical history of heart disease, low or high blood pressure, circulatory system problems, diabetes, infectious diseases or immune deficiency syndromes should consult a physician before using a spa.
 - If you experience breathing difficulties in association with using or operating your spa, discontinue use and consult your physician.
 - Persons using medication should consult a physician before using a spa since some medication may induce drowsiness, while other medication may affect heart rate, blood pressure, and circulation.
 - Persons suffering from any condition requiring medical treatment, the elderly, or infants should consult with a physician before using a spa.
 - The use of alcohol, drugs, or medication before or during spa use may lead to unconsciousness with the possibility of drowning.
7.  **WARNING: RISK OF SEVERE INJURY OR DEATH!**
- Prolonged immersion in a spa may be injurious to your health.
 - Observe a reasonable time limit when using the spa. Exposures at higher temperatures can cause high body temperature (overheating). Symptoms may include dizziness, nausea, fainting, drowsiness, and reduced awareness. These effects could possibly result in drowning or serious injury.
 - Never use a spa immediately following strenuous exercise. Enter and exit the spa slowly. Wet surfaces can be slippery.
8.  **WARNING: TO DECREASE RISK OF INFECTION OR DISEASE!**
- To reduce the risk of contracting a waterborne illness (e.g. an infection, bacteria or virus) and/or respiratory ailments, maintain water chemistry within the parameters listed on the inside cover of this manual and consult with a licensed engineer regarding proper ventilation if installed indoors or in an enclosed area.
 - People with infectious diseases should not use a spa to avoid water contamination, which could result in spreading infections to others.
 - Always shower before and after using your spa. Maintain water chemistry in accordance with manufacturer's instructions. Failure to do so may result in contracting a waterborne illness (e.g. an infection, bacteria or virus).

9.  **WARNING:** In addition to maintenance of filters and water chemistry, proper ventilation is recommended to reduce the risk of contracting a waterborne illness (e.g. an infection, bacteria or virus) and/or respiratory ailments that could be present in the air or water. Consult a licensed architect or building contractor to determine your specific needs if installing your hot tub indoors.
10. **CAUTION: TO DECREASE RISK OF PRODUCT DAMAGE.**
- Maintain water chemistry in accordance with manufacturer's instructions.
 - Proper chemical maintenance of spa water is necessary to maintain safe water and prevent possible damage to spa components.
11.  **WARNING: RISK OF SEVERE INJURY OR DEATH!**
The appliance is not intended for use by persons (including children) with reduced physical, sensory or mental capabilities, or lack of experience or knowledge, unless they have been given supervision or instruction concerning use of the appliance by a person responsible for their safety.
12. **NOTE:** This spa is not intended nor designed to be used in a commercial or public application. The spa buyer shall determine whether there are any code restrictions on the use or installation of this spa since local code requirements vary from one locality to another.

Hot Tub Safety Literature

To ensure you have a safe and enjoyable hot tub experience, learn all you can about hot tub safety and emergency procedures.

The Pool & Hot Tub Alliance has a great source of safety literature.

- Go to <http://phta.org>
- Conduct your own search on the internet
- Write to the following address:

Pool & Hot Tub Alliance
2111 Eisenhower Avenue
Alexandria VA 22314
703.838.0083

Proposition 65 (FOR CALIFORNIA RESIDENTS ONLY)



WARNING: Cancer and Reproductive Harm
www.p65Warnings.ca.gov

3.1 Entrapment Risk



The Consumer Products Safety Commission/USA has reported that users of pools and spas have become entrapped (stuck) to drain and/or suction fittings causing death, drowning, or serious injury (see diagram below). This spa was manufactured to meet the standards and specifications outlined in the “Virginia Graeme Baker Pool and Spa Safety Act” (VGB Safety Act). Entrapment risk can be minimized if proper precautions are taken.



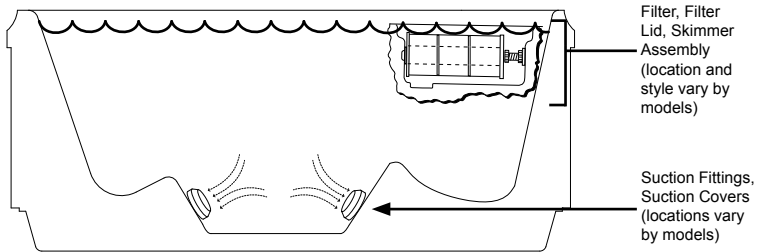

DANGER: RISK OF PERSONAL INJURY OR DEATH! Never operate the spa if a suction fitting, suction cover, filter, filter lid or skimmer assembly are broken, damaged or missing.



NOTE: SUCTION COVERS MUST BE REPLACED EVERY 7 YEARS.

1.  **DANGER: RISK OF SEVERE INJURY OR DROWNING!**
Hair entrapment: May occur if hair is entangled, knotted or snagged in a drain suction or skimmer assembly. This has been reported in persons who when submerge themselves underwater, allowing hair to come close and/or within the reach of the suction fittings, suction covers or skimmer assembly.
 - Keep hair away from suction fittings, suction covers, filter, filter lid or skimmer assembly.
 - Children are at risk for hair entrapment if swimming under water.
 - Never allow children to play or get near the suction fittings, suction covers, filter, filter lid or skimmer assembly.
2.  **DANGER: RISK OF SEVERE INJURY OR DROWNING!**
Limb entrapment: May occur when a limb becomes entrapped, inserted or sucked into a suction or outlet opening.
 - Always keep suction fittings, suction covers, filter, filter lid or skimmer assembly in place when operating to avoid limb entrapment.
 - Never allow children to play or get near the suction fittings, suction covers, filter, filter lid or skimmer assembly.

3.  **DANGER: RISK OF SEVERE INJURY OR DROWNING!**
Body entrapment: May occur when part of the torso becomes entrapped, inserted or sucked into a suction or outlet opening.
 - Never allow children to play or get near the suction fittings, suction covers, filter, filter lid or skimmer assembly.
4.  **DANGER: RISK OF SEVERE INJURY OR DROWNING!**
Evisceration (disembowelment) entrapment: May occur when the buttocks becomes entrapped, inserted or sucked into a suction or outlet opening.
 - Never sit or stand on the suction fittings, suction covers, filter or skimmer assembly.
 - Never allow children to play or get near the suction fittings, suction covers, filter, filter lid or skimmer assembly.
5.  **DANGER: RISK OF SEVERE INJURY OR DROWNING!**
Mechanical entrapment: May occur when jewelry, swimsuit, or hair accessories become entangled, knotted or snagged in a drain suction or skimmer assembly.
 - Never allow your jewelry, swimsuit, or hair accessories to come close to the suction fittings, suction covers or skimmer assembly.
 - Never allow children to play or get near the suction fittings, suction covers, filter, filter lid or skimmer assembly.

3.2 Hyperthermia

Prolonged immersion in hot water may induce hyperthermia (overheating). The use of alcohol or drugs can greatly increase the risk of fatal hyperthermia in spas. A description of the causes, symptoms, and effects of hyperthermia are as follows:

Hyperthermia occurs when the internal temperature of the body reaches a level several degrees above the normal body temperature of 98.6°F (37°C). The symptoms of hyperthermia include drowsiness, lethargy (fatigue), and an increase in the internal temperature of the body (feeling of being too hot). The effects of hyperthermia include:

- Unawareness of impending hazard;
- Failure to perceive heat;
- Failure to recognize the need to exit spa;
- Physical inability to exit spa;
- Fetal damage in pregnant women; and
- Unconsciousness and danger of drowning.

A Warning Sign is provided in your warranty packet. Please install at a location near your spa, where it is visible to users of the spa. For additional or replacement Warning Signs please contact your local Sundance spas dealer and reference item number #6530-082.

3.3 Important Additional Safety Instructions

When using this electrical equipment, basic safety precautions should always be followed, including the following:

1. **READ AND FOLLOW ALL INSTRUCTIONS.**
2. A green colored terminal or a terminal marked G, Gr, Ground, Grounding or the Ⓧ symbol* is located inside the supply terminal box or compartment. To reduce the risk of electric shock, this terminal must be connected to the grounding means provided in the electric supply service panel with a continuous copper wire equivalent in size to the circuit conductors that supply this equipment (*IEC Publication 417, Symbol 5019).
3. At least two lugs marked "Bonding Lugs" are provided on the external surface or on the inside of the supply terminal box/compartment. To reduce the risk of electric shock, connect the local common bonding grid in the area of the spa to these terminals with an insulated or bare copper conductor not smaller than No. 6 AWG (10 mm²).
4. All field installed metal components such as rails, ladders, drains or other similar hardware within 10 feet (3m) of the spa shall be bonded to the equipment grounding buss with copper conductors not smaller than No. 6 AWG (10 mm²).
5. **SAVE THESE INSTRUCTIONS.**

3.4 PRECAUTIONS-Important Chemical Safety

Do not use this device with bromide products.

3.5 PRECAUTIONS FOR USE OF PRODUCTS CONTAINING SODIUM BROMIDE

- Do not use any Product containing Sodium Bromide with an electrolysis device (for example, a chlorine generator).
- Do not use any Product containing Sodium Bromide with ozonation.
- Do not use any Product containing Sodium Bromide with ultraviolet (UV).

4.0 Locating Your Sundance Hot Tub

IMPORTANT: Because of the combined weight of the spa, water and users, it is extremely important that the base upon which the spa rests be smooth, flat, level and capable of uniformly supporting this weight, without shifting or settling, for the entire time the spa is in place. Visit www.SundanceSpas.com for weight information. If the spa is placed on a surface which does not meet these requirements, damage to the skirt and/or the spa shell may result. Damage caused by improper support is not covered under warranty. It is the responsibility of the spa owner to assure the integrity of the support over time. We recommend a poured, reinforced concrete slab with a minimum thickness of 4 inches (10 cm). Wood decking is also acceptable provided it is constructed so that it meets the requirements outlined above.



WARNING: For spas that are to rest on balconies, roofs or other platforms not specifically tied into main structural support, consult a professional Structural Engineer with experience in this type of application.



WARNING: Proper drainage is required. The installation must not allow the spa equipment bay to become flooded or wetted (by external water). It is your responsibility, and the responsibility of any installation contractor you hire, to make sure that all applicable codes and/or local construction requirements are met. If in doubt, refer to the building authority responsible for approving the proposed installation site.

The spa must be installed in such a manner as to provide drainage away from it. Placing the spa in a depression without provisions for proper drainage could allow rain, overflow, leaks from spa plumbing, and other casual water to flood the equipment and create a wet condition in which it would sit in. For spas which will be installed below grade or recessed into a floor or deck, install so as to permit access to the equipment, either from above or below, for servicing. Make certain that there are no obstructions which would prevent removal of all side cabinet panels and access to components, especially on the side with the equipment bay doors.



CAUTION: If the spa is indoors or located in an enclosed area, proper ventilation should be discussed with an Engineer or authority competent enough to understand the necessary provisions needed to vent moist or heated air and air associated with chemical odors outdoors. **When the spa is in use considerable amounts of moisture will escape potentially causing mold and mildew.** This can cause health risk. Over time, this can damage certain surfaces, surroundings, and equipment.

4.1 Outdoor Location

In selecting the ideal outdoor location for your hot tub, we suggest that you take into consideration the following:

- The proximity to changing area and shelter (especially in regions subject to cold weather).
- The pathway to and from your hot tub (this should be free of debris so that dirt and leaves are not easily tracked into the hot tub).
- The closeness to trees and shrubbery (remember that leaves and birds could create extra work in keeping the hot tub clean).
- A sheltered environment (less wind and weather exposure can result in lowered operation and maintenance costs).
- The overall enhancement of your environment. It is preferable not to place the hot tub under an unguttered roof overhang since run-off water will shorten the life expectancy of the hot tub cover.
- For spas that are to rest on balconies, roofs or other platforms not specifically tied into main structural support, consult a professional Structural Engineer with experience in this type of application.
- In the unlikely event that you should ever need to access or gain entry to any portion of the spa for servicing, it is highly recommended that you plan your outdoor installation to provide full access to the entire spa. Please take this into consideration when placing the spa in a deck or enclosed by a surrounding.
- Consider locating your spa away from any reflective surface or glass to prevent any damage to the synthetic skirt.
- Do not shim the spa. To ensure proper support the spa must sit flat on the intended foundation.

4.2 Indoor Location

For indoor installations many factors need to be considered before installing a spa indoors:



WARNING: In addition to maintenance of filters and water chemistry, proper ventilation is recommended to reduce the risk of contracting a waterborne illness (e.g., an infection, bacteria or virus) and/or respiratory ailments that could be present in the air or water. Consult a licensed architect or building contractor to determine your specific needs if installing your hot tub indoors.

- **PROPER FOUNDATION:** Consult a Structural Engineer when considering a foundation that will adequately support the spa the entire time it is in place. Proper support is critical especially if the spa is to rest on a second story or higher. For spas that are to rest on balconies, roofs or other platforms not specifically tied into the main structural support, you should consult a professional Structural Engineer with experience in this type of application.
- **PROPER DRAINAGE:** It is extremely important to have in place measures to sufficiently handle excessive water spillage. Be sure the flooring in which the spa rests on has adequate drainage

and can handle draining of the entire contents of the spa. Be sure to make provisions for ceilings or any other structures that may be below the spa's installation. Areas around your spa can become wet or moist so all flooring and subsequent furniture, walls and adjacent structures should be able to withstand or resist water and moisture.

- **PROPER VENTILATION:** Proper ventilation should be discussed with an Engineer or authority competent enough to understand the necessary provisions needed to vent moist or heated air and air associated with chemical odors outdoors. When the spa is in use considerable amounts of moisture will escape potentially causing mold and mildew, over time this can damage certain surfaces and or surroundings.
- **SUFFICIENT ACCESS:** In the unlikely event that you should ever need to access or gain entry to any portion of the spa for servicing, it is highly recommended that you plan your indoor installation to provide full access to the entire spa.
- **WARRANTY:** Damage caused by not following these guidelines or any improper installation not in accordance with local codes or authorities is not covered under the spas warranty. Please consult your local state or city building ordinances.
- **DO NOT SHIM THE SPA.** To ensure proper support the spa must sit flat on the intended foundation.

5.0 General Electrical Safety Instructions

Your new Sundance® hot tub is equipped with the “state-of-the-art” equipment system. It contains the most advanced safety and self-protective equipment in the industry.

Nonetheless, this hot tub must be installed properly to ensure dependable usage. Please contact your local Sundance Spas dealer or local building department should you have any questions regarding your installation.

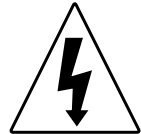

Proper grounding is extremely important. Sundance hot tubs are equipped with a current collector system. A pressure wire connector is provided on the surface of the control box, located inside the equipment door (Figure C, page 15) to permit connection of a bonding wire between this point and any ground metal equipment, metal water pipe or conduit within 5 feet (1.5m) of the hot tub, or copper clad grounding rod buried within 5 feet (1.5m) of the hot tub. Bonding wire must be at least No. 8 AWG (8.4 mm²) solid copper wire. This is a most important safety assurance feature.

Before installing your hot tub, check with your local government/electrical authority to ensure installation conforms to local country/area state codes.

6.0 Electrical Installation Instructions (240V Service)

IMPORTANT NOTICE: The electrical wiring of this hot tub must meet the requirements of the National Electrical Code (NEC) and/or any applicable state, local or country codes. The electrical circuit must be installed by a qualified electrician and approved by a local building/electrical inspection authority in your state or country.

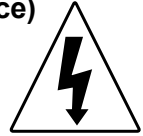

1.  **DANGER: TO DECREASE THE RISK OF SHOCK, PRODUCT DAMAGE OR ELECTRICAL FIRE.**

This hot tub must be permanently connected (hard-wired) to the power supply. **No plug-in connections or extension cords are to be used in conjunction with the operation of this hot tub.**

Supplying power to the hot tub which is not in accordance with these instructions will void both the independent testing agency listing and the manufacturer's warranty.

2. The power supplied to this hot tub must be a dedicated circuit with no other appliances or lights sharing the power provided by the circuit.
3. To determine the current, voltage and wire size required, refer to Section 7.0 (page 16) for your specific hot tub model.
 - Wire size must be appropriate per NEC and/or local/country codes.
 - The spa controller's terminal block will accept a maximum wire size of 6 AWG (10 mm²).
4. The electrical supply for this product must include a suitably rated switch or circuit breaker to open all ungrounded supply conductors to comply with Article 422.20 of the National Electrical Code, ANSI/NFPA 70. The disconnecting means must be readily accessible and visible to the hot tub's occupant but installed at least 5 feet (1.5m) from the hot tub.
5. The electrical circuit supplied for the hot tub must include a suitable ground fault circuit interrupter (GFCI) as required by NEC Article 680.42.
6. To gain access to the spa's power terminal block (Figure 1):
 - Remove both corner panels. Grab one of the corner panels, from the top, and gently pull the cabinet forward to unsnap it from the holding clip. Then slide it up to remove. Now remove the center cabinet by grabbing the bottom of the panel and lifting it up to release from the top mounting bracket. Then slightly tilt and pull down on the panel to remove. Place the panel in a safe location to prevent from damaging it. Reference page 70, for instructions. Then remove the control box door screws and door (Figure C, page 15).

7. Select the power supply entrance you want to use (Figures A-B, page 14) and feed cable through the large opening provided on the bottom of the control box.
8. Connect wires, color to color, on terminal blocks TB1 (Figure D). **TIGHTEN SECURELY!** All wires must be hooked up securely or damage could result.
9. Install control box door and reinstall the cabinet panel(s).

Note: Exposure of the cabinet to heat could cause the cabinet to warp. Should the cabinet warp, once it is installed, the warping is not visible. However, it does make the removal and replacement a little more challenging.



IMPORTANT NOTICE : Remove the shipping bolts and spacers from the circulation pump prior to operation. Failure to do so may result in loud pump noise. Store the bolts and spacers in a safe location. Reinstall them if you move, tilt, or ship the hot tub.

Figure 1

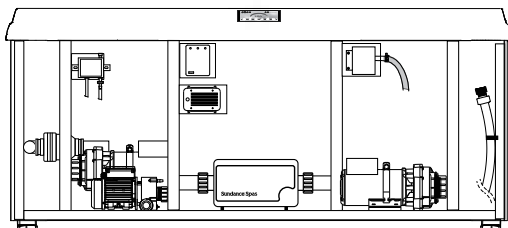
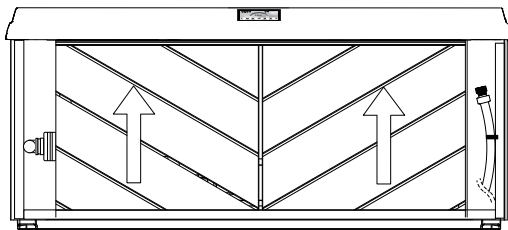
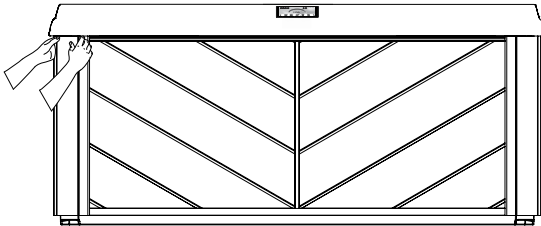
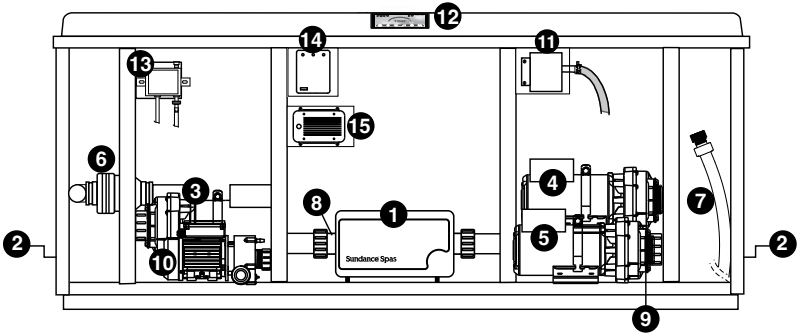

Figure A



Note: Equipment location (such as pumps, CLEARRAY®, drain, heater etc.) varies by model.

- | | |
|-----------------------------|--|
| 1. Control Box | 9. Pump Drain Plug(s) |
| 2. Power Supply Entrance(s) | 10. Filter/Circulation Pump |
| 3. Jets Pump | 11. CLEARRAY® |
| 4. Jets Pump | 12. Control Panel |
| 5. Jets Pump | 13. CLEARRAY® PRO ₃ TECT |
| 6. Blower | 14. SmartTub® System (Optional) |
| 7. Hot Tub Drain | 15. BLUEWAVE® 2.0 Wireless Audio System (Optional) |
| 8. Heater | |

Figure B

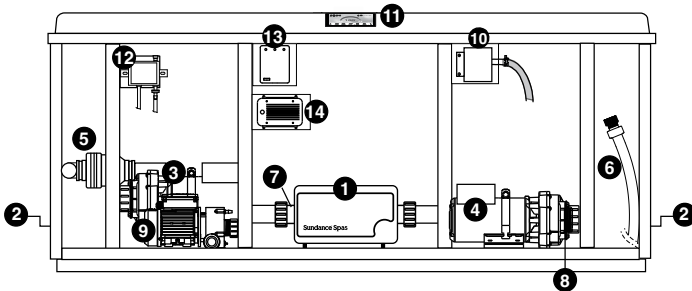

Note: Equipment location (such as pumps, CLEARRAY®, drain, heater etc.) varies by model.

- | | |
|-----------------------------|--|
| 1. Control Box | 8. Pump Drain Plug(s) |
| 2. Power Supply Entrance(s) | 9. Filter/Circulation Pump |
| 3. Jets Pump | 10. CLEARRAY® |
| 4. Jets Pump (if equipped) | 11. Control Panel |
| 5. Blower | 12. CLEARRAY® PRO ₃ TECT |
| 6. Hot Tub Drain | 13. SmartTub® System (Optional) |
| 7. Heater | 14. BLUEWAVE® 2.0 Wireless Audio System (Optional) |

Figure C
Control Box

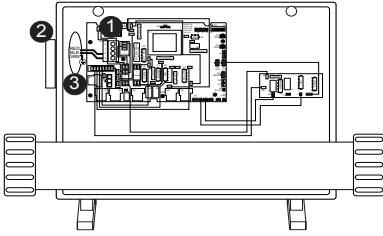

- 1. Terminal Block
- 2. Bonding Lug
- 3. Electrical Wires Entrance

Figure D
Terminal Block 240V
Wire Connection

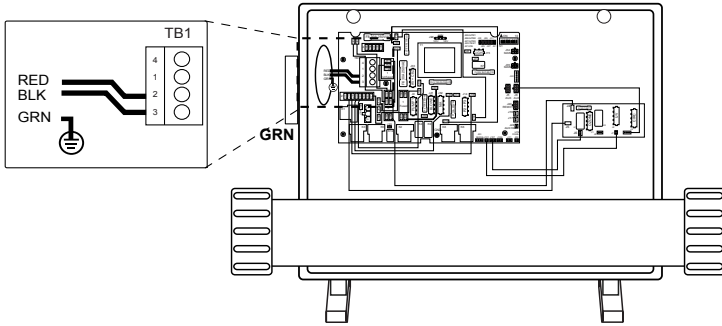

7.0 Power Requirements

Sundance® hot tubs are designed to provide optimum performance and flexibility of use when connected to their maximum electrical service. However, they are shipped factory configured for their most common preferred electrical connection. If you prefer, a qualified technician can perform a minor circuit board modification that allows the hot tub to operate on a different electrical service. We recommend using a Square D breaker.

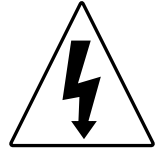

The electrical wiring of this hot tub must meet the requirements of the National Electrical Code (NEC) and/or any applicable state, local or country codes.

North American 60 Hz			
Voltage	240 VAC	240 VAC	240 VAC
<u>Max. Current Draw:</u>			
1-Pump System	28A	39A	N/A
2-Pump System	28A	39A	48A
3-Pump System	N/A	39A	48A
Frequency:	60 Hz	60 Hz	60 Hz
Number of Wires:	3	3	3
Circuit Breaker (2-Pole):	40A*	50A**	60A***
<p>* In the 40A configuration, the heater will not operate while any jets pump is running. <u>Not recommended for the Aspen.</u></p> <p>** In the 50A configuration, the heater will operate when one jets pump and the blower are running, but will not operate while two jets pumps are running. <u>This is the factory default setting for 1-pump and 2-pump systems.</u></p> <p>*** In the 60A configuration, the heater will operate while two jets pumps are running, but will not operate if three jets pumps are running or if two jets pumps and blower are running.</p>			

8.0 Hot Tub Fill Up Procedure

For best results, read each step in its entirety before proceeding with that step. **Make sure all drains are closed prior to filling spa, page 14.**

1. Prepare The Hot Tub For Filling

- Clear all debris from the hot tub. (Although the hot tub shell has been polished at the factory, you may want to treat it with a specially formulated hot tub cleaner.) Consult your dealer for additional information prior to filling hot tub.

IMPORTANT: In most cases, filling the spa by placing the hose in the footwell will not create an airlock. If you experience an airlock we recommend filling by placing the end of your garden hose into the primary filter inlet, page 68.

2. Fill Hot Tub

- Place the end of your garden hose into the one of the following, the primary filter inlet or footwell. Fill until water covers all jets but does not touch the bottom of the lowest headrest.

CAUTION: TO DECREASE BUILD UP ON COMPONENTS AND MINIMIZE ACRYLIC DAMAGE. Never fill with water from a water softener. If your water is extremely “hard,” it is preferable to fill half-way with hard water and the rest of the way with softened water. Water that is too soft can be corrosive to metal components.

-  **WARNING: TO DECREASE RISK OF INFECTION OR DISEASE.**

Fill hot tub with clean tap water from garden hose, to reduce risk of contracting a waterborne illness (e.g. an infection, bacteria or virus) and/or respiratory ailments. Fill until water covers all jets but does not touch the bottom of the lowest headrest. (DO NOT OVERFILL!)

3. Turn On Power (Priming Mode)

Turn on power to hot tub at the home's circuit breaker. the hot tub will begin a start start-up sequence. After the start-up sequence, the hot tub will be ready for the priming cycle and the following menu will appear.

Note: Menu could differ from one shown.



The components must be manually activated. They do not come on automatically.

- Priming Cycle last around 4 minutes.
- Press Jets 1 button to activate pump 1.
- Press Jets 2 button to activate pump 2.
- Press Jets 3 button to activate pump 3.
- Press Circ button to activate Circulation pump.
- The current water temperature will display after 1 minute.
- The hot tub will automatically begin heating and filtering at the end of the priming cycle. The Main Menu will display.

Note: You can skip the Priming Mode by pressing  when you enter the Priming Mode Menu. This is not recommended.

4. Activate Jets Pumps

Turn on all jet(s) pumps and blower (page 44) to ensure proper mixing when adding start up chemical in step 5.

5. Add Start-Up Chemicals

Add the hot tub water chemicals as recommended by your Sundance Spas dealer. See Section titled “Water Quality Maintenance” (page 75) for general guidance.



WARNING: RISK OF POISONING OR DEATH. Never leave chemicals opened and accessible to anyone. Use chemicals according to the vendors instructions. Always store chemicals in a safe and/or locked location. Keep away from and out of reach of children.

6. Establish A Stable Sanitizer Reading

Establish a stable sanitizer reading no less than 1.0 ppm free chlorine or 2.0 ppm bromine. To ensure healthy water conditions, always maintain a constant sanitizer reading within the levels recommended on the inside cover of this manual.

7. Set Hot Tub To Heat

To warm the hot tub water to a comfortable temperature, follow these steps:

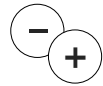

- The LCD display on the control panel displays the actual temperature of the hot tub water. Press either the **COOLER** (-) or the **WARMER** (+) to set the temperature. To see the current set temperature tap the temperature displayed. The set temperature increases or decreases by 1°F (0.5°C) each time either button is pressed.
- The heater will turn off when the temperature corresponding to the thermostat setting is achieved.

Important Heater Details:

- The maximum temperature for which the hot tub can be set is 104°F (40°C) and the minimum is 65°F (18.5°C).
- For hot tubs powered with a 40-amp service, turn off jets pump #1 and jets pump #2 to operate heater.
- Setting the thermostat at maximum will not accelerate the heating process. This will only result in a higher ultimate temperature.
- The heater operates until the water reaches the programmed “set temperature,” then turns off. The heater will reactivate after the water cools to approximately 2°F (1°C) below the “set temperature.”

8. Place Cover On Hot Tub

- Keeping the insulating cover in place anytime the hot tub is not in use will reduce the time required for heating, thereby minimizing operating costs.
- The time required for initial heat-up will vary depending on the starting water temperature.

**DANGER: RISK OF PERSONAL INJURY.**

Check water temperature carefully before entering hot tub!
Excessive water temperature can cause burns, welts and body temperature to rise, hyperthermia (over-heating).

Decontamination Procedure (Steps 9-15)

Steps 9-15 below are only required when sanitizer levels are unstable after performing steps 1-6 above. Disregard steps 9-15 below if sanitizer levels remain stable after performing steps 1-6 above (refer to the inside cover of the manual).

Note: The “decontamination procedure” steps 9-15 should also be used after the hot tub has been “Winterized” (Section 13.8) or has been sitting without power for an extended period.

- Add 2.5 ounces (71 g.) of sodium dichlor for every 100 gallons (378 L.) of water. Refer to the table (below) for approximate water fill capacity by model.

**CAUTION: RISK OF PERSONAL INJURY OR SPA DAMAGE!**

Never add chlorine tablets (trichlor) or acid to your hot tub for any reason! These chemicals may damage components within your hot tub, burn or irritate your skin, create a rash, and void the manufacturer warranty for your spa.

Water Fill Volume

Model	Average Fill Volume*	Sodium Dichlor
Altamar	305 Gal (1,155 L)	8.0 oz
Aspen	505 Gal (1,921 L)	13.0 oz
Cameo	350 Gal (1,325 L)	9.0 oz
Capri	195 Gal (738 L)	5.0 oz
Marin	295 Gal (1,117 L)	7.0 oz
Optima	355 Gal (1,344 L)	9.0 oz
Vistamar	330 Gal (1,249 L)	8.0 oz

*Use average fill volume for chemical maintenance

- Leave hot tub cover open during this step to allow excessive chemical vapors to exit hot tub, protecting pillows and plastic knobs from chemical attack. If hot tub is indoors, open doors and windows for proper ventilation. Turn on all hot tub jets pumps for one hour, open all air controls, turn on the blower, and place all massage selector knob(s) in their center “combo” position as shown (right).

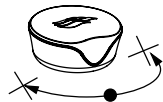

Note: You will need to press the jets pump button(s) and blower button every 20 minutes since these functions have an automatic 20 minute time-out function that turns them off.



WARNING: RISK OF PERSONAL INJURY!

- To decrease the risk of injury, drowning or entrapment, never leave your hot tub unattended for any reason while the cover is open and accessible, especially to small children and animals!
- Precautions should be taken to minimize your exposure to chemical vapors (that could cause lung, brain, or skin damage).

11. Turn off power to the hot tub at the circuit breaker, then drain tub as outlined in Section 13.3 (page 71).
12. Refill hot tub with clean tap water from garden hose until water covers all jets but does not touch the bottom of the lowest headrest. (DO NOT OVERFILL!)

CAUTION: TO DECREASE BUILD UP ON COMPONENTS AND MINIMIZE ACRYLIC DAMAGE.

Never fill with water from a water softener. If your water is extremely “hard,” it is preferable to fill half-way with hard water and the rest of the way with softened water. Water that is too soft can be corrosive to metal components.

13. Consult your authorized Sundance® Spas dealer for chemical recommendations, then add chemicals to hot tub water to achieve a constant sanitizer reading within the levels recommended on the inside cover of this manual.
14. Turn on all jet pumps and the blower when adding chemicals to ensure proper mixing and leave your hot tub cover open until the sanitizer level becomes stable to protect pillows and plastic knobs from chemical attack. Refer to the inside cover of the manual.



WARNING: RISK OF PERSONAL INJURY.

- To decrease the risk of injury, entrapment or drowning, never leave your hot tub unattended for any reason, especially if while the cover is open and accessible to small children and animals!
- To decrease the risk of contracting a waterborne illness (e.g. an infection, bacteria or virus) and/or respiratory ailments, maintain water chemistry within 6 step parameters. If you or other bathers experience such a condition, discontinue use and seek immediate medical attention.

15. Establish a sanitizer reading no less than 1.0 ppm free chlorine or 2.0 ppm bromine, then allow the hot tub to set undisturbed for 8 hours. Retest water after 8 hours to determine if sanitizer levels are stable. If sanitizer levels are stable, your hot tub is ready for use. To ensure healthy water conditions, always maintain a constant sanitizer reading within the levels recommended on the inside cover of this manual. If sanitizer levels are not stable at this time, it will be necessary to repeat this procedure in its entirety (steps 1-15) until stable sanitizer readings are achieved.

IMPORTANT: If the CLEARRAY Active Oxygen™ water purification system is removed from the hot tub or is not operating efficiently follow the “without CLEARRAY®” water chemistry parameters. Such parameters are defined by the Pool & Hot Tub Alliance.

16. After adequate sanitizer levels are achieved, close all spa air controls by rotating them counterclockwise to maximize heat retention when spa is not in use.

9.0 Hot Tub Features

9.1 Aspen® Hot Tub Features

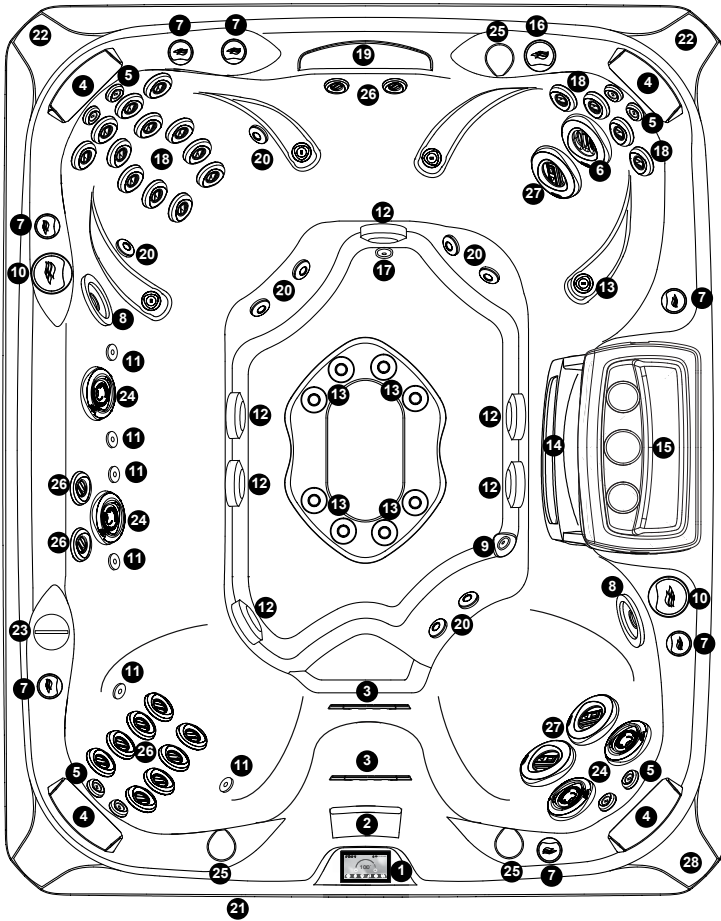

- | | |
|--|---|
| 1. Main Control Panel | 16. Waterfall Control Valve |
| 2. Handrail with LED Light | 17. Waterfall Filtration Return |
| 3. Lights (2 ea.) | 18. Fluidix ST™ Jets (16 ea.) |
| 4. Pillows (4 ea.) | 19. Waterfall |
| 5. Fluidix Nex™ Jets (8 ea.) | 20. Focus Relief™ Jets (8 ea.) |
| 6. Fluidix Intelli-Jet™ (6 ea.) | 21. Optional BLUEWAVE® 2.0 Wireless Spa Stereo (behind cabinet) |
| 7. Air Controls with LED Light (7 ea.) | 22. Optional Audio System Speakers (2 ea.) |
| 8. Whirlpool™ Jets (2 ea.) | 23. Sunscents™ Dispenser |
| 9. Gravity Drain | 24. Vortex™ Jets (4 ea.) |
| 10. Massage Selectors (2 ea.) | 25. Integrated cupholders (4 ea.) |
| 11. Air Injectors (6 ea.) | 26. Fluidix Reflex™ Jets (12 ea.) |
| 12. Suction Covers (6 ea.) | 27. Fluidix PT™ Jets (2 ea.) |
| 13. Accu-Pressure™ Jets (8 ea.) | 28. Optional Integrated Charger |
| 14. Weir Gate/Skimmer | |
| 15. Filter Lid | |

Spa features subject to change without notice.

9.2 Aspen Massage/Waterfall Selector Diagram

Massage Selector Operation

Rotate Massage Selectors 1 and 2 to divert water between designated jet groups.

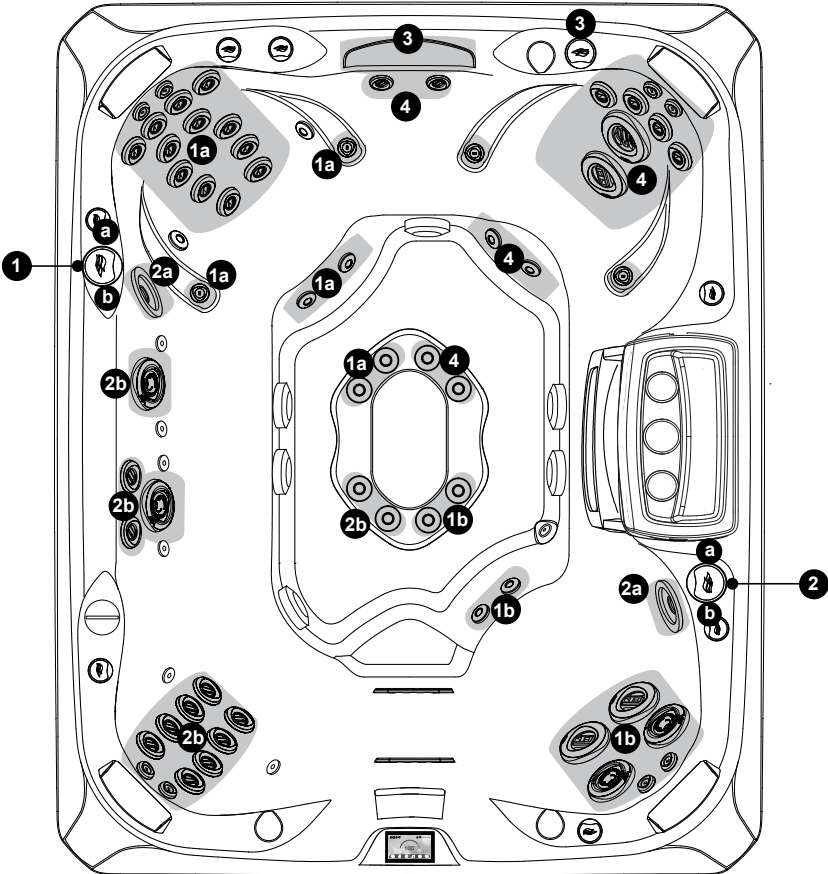

Massage Selectors (1-2)

- Massage Selector #1 controls pump #2.
- Massage Selector #2 controls pump #1.

Waterfall Selector (3)

- Waterfall Selector #3 controls circulation pump output to waterfall.

Continuously Powered Jets

- Jets #4 are always on when jets pump #3 is running.

Spa operation subject to change without notice.

9.3 Aspen Air Controls Diagram

Air Control Operation

Rotate Air Controls 1-7 to add air to designated jet groups.
Turn the Blower on to add air to jets group 8.

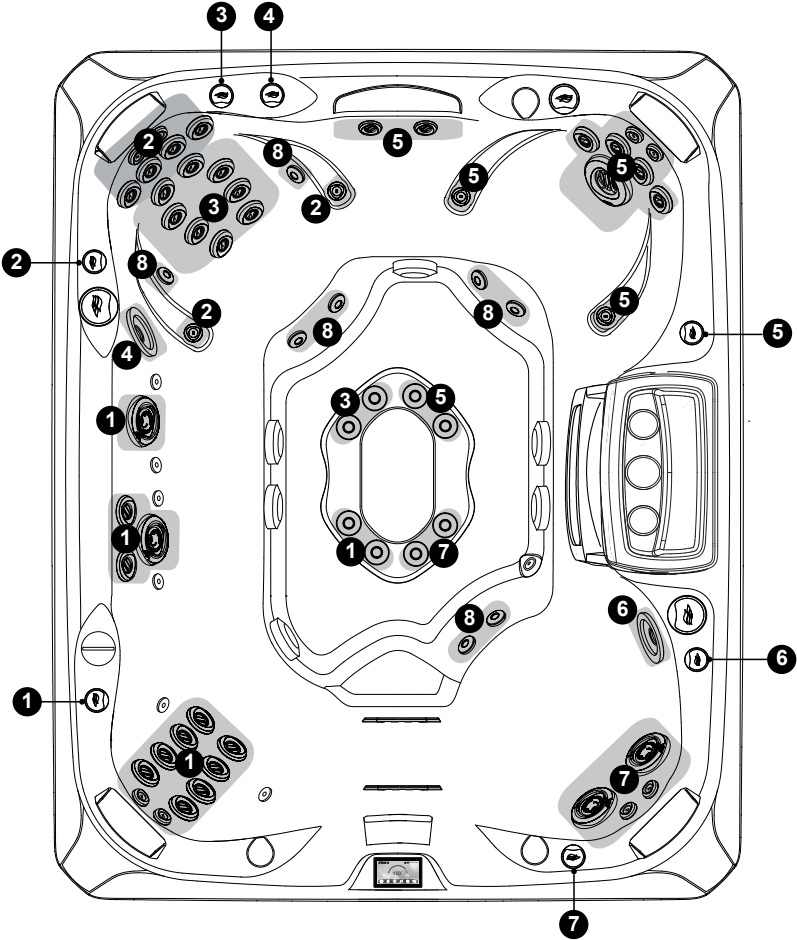

Spa operation subject to change without notice.

9.4 Optima® Hot Tub Features

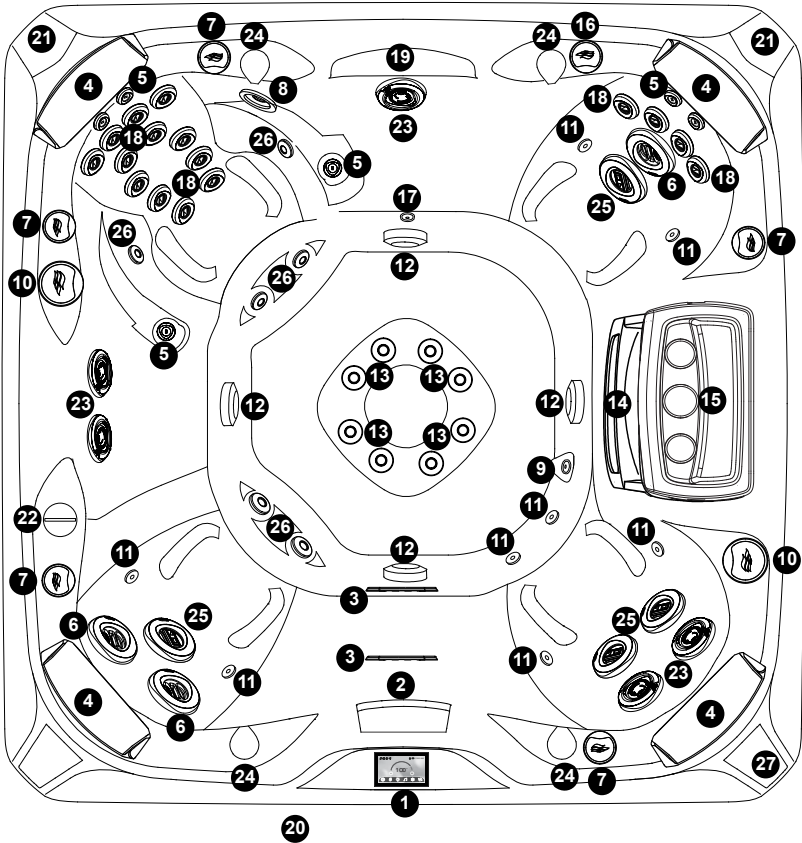

- | | |
|-------------------------------------|---|
| 1. Main Control Panel | 16. Waterfall Control Valve |
| 2. Handrail with LED Light | 17. Waterfall Filtration Return |
| 3. Light | 18. Fluidix ST™ Jets (16 ea.) |
| 4. Pillows (4 ea.) | 19. Waterfall |
| 5. Fluidix Nex™ (6 ea.) | 20. Optional BLUEWAVE® 2.0
Wireless Spa Stereo (behind
cabinet) |
| 6. Fluidix Intelli-Jet™ (3 ea.) | 21. Optional Audio System Speak-
ers (2 ea.) |
| 7. Air Controls w/LED Light (5 ea.) | 22. Sunscents Dispenser |
| 8. Whirlpool Jets (1 ea.) | 23. Vortex™ Jets (5 ea.) |
| 9. Gravity Drain | 24. Integrated Cupholders (4 ea.) |
| 10. Massage Selectors (2 ea.) | 25. Fluidix PT™ Jets (4 ea.) |
| 11. Air Injectors (8 ea.) | 26. Focus Relief™ Jets (6 ea.) |
| 12. Suction Covers (4 ea.) | 27. Optional Integrated Charger |
| 13. Accu-Pressure™ Jets (8 ea.) | |
| 14. Weir Gate/Skimmer | |
| 15. Filter Lid | |

Spa features subject to change without notice.

9.5 Optima Massage/Waterfall Selector Diagram

Massage Selector Operation

Rotate Massage Selectors 1 and 2 to divert water between designated jet groups.

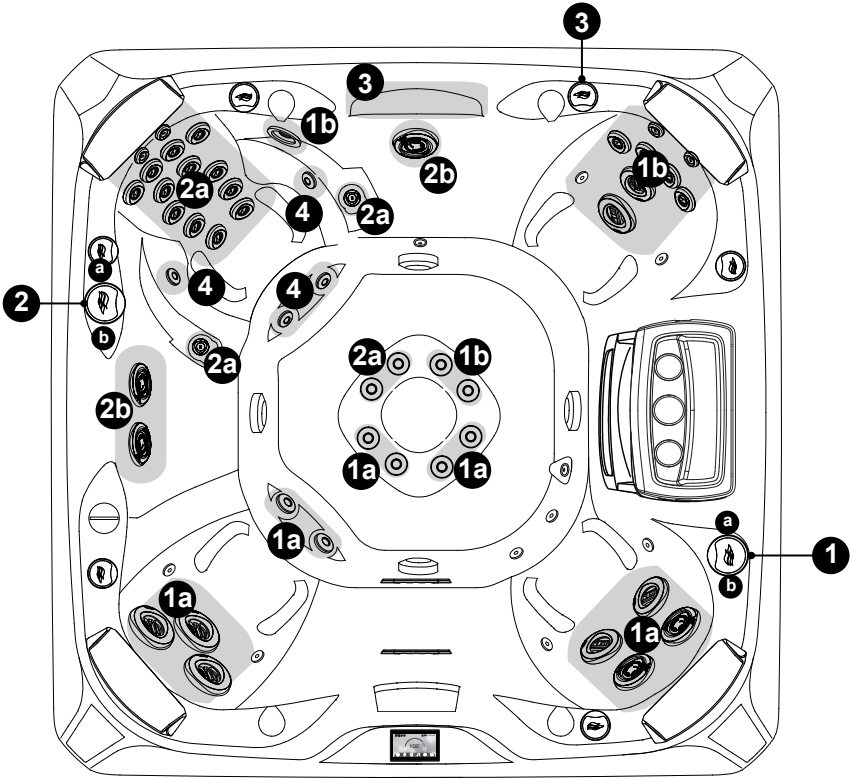

Massage Selectors (1-2)

- Massage Selector #1 controls pump #1.
- Massage Selector #2 controls pump #2.

Waterfall Selector (3)

- Waterfall Selector #3 controls circulation pump output to waterfall.

Continuously Powered Jets

- Jets #4 are always on when jets pump #1 is running.

Spa operation subject to change without notice.

9.6 Optima Air Controls Diagram

Air Control Operation

Rotate Air Controls 1-5 to add air to designated jet groups.
Turn the Blower on to add air to jets group 6.

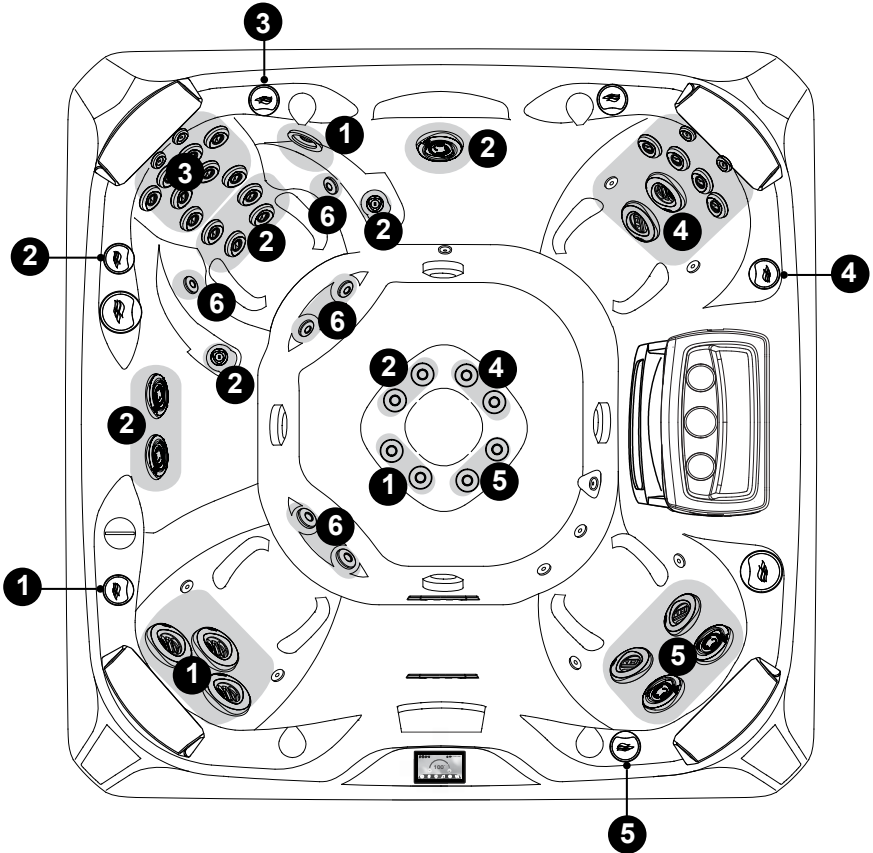

Spa operation subject to change without notice.

9.7 Cameo® Hot Tub Features

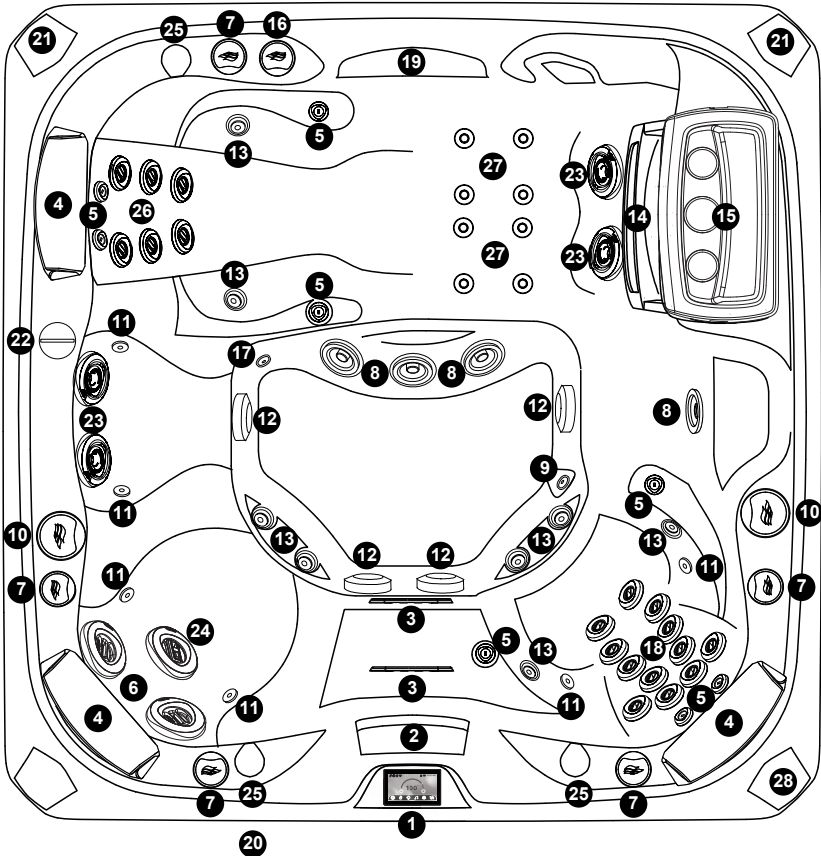

- | | |
|-------------------------------------|---|
| 1. Control Panel | 17. Waterfall Filtration Return |
| 2. Handrail with LED Light | 18. Fluidix ST™ Jets (12 ea.) |
| 3. Lights | 19. Waterfall |
| 4. Pillows (3 ea.) | 20. Optional BLUEWAVE® 2.0
Wireless Spa Stereo (behind
cabinet) |
| 5. Fluidix Nex™ Jets (6 ea.) | 21. Optional Audio System Speak-
ers (2 ea.) |
| 6. Fluidix Intelli-Jet™ (2 ea.) | 22. Suncents Dispenser |
| 7. Air Controls w/LED Light (5 ea.) | 23. Vortex™ Jets (4 ea.) |
| 8. Whirlpool Jets (4 ea.) | 24. Fluidix PT™ Jet |
| 9. Gravity Drain | 25. Integrated Cupholders (3 ea.) |
| 10. Massage Selectors (2 ea.) | 26. Fluidix Reflex™ Jets (6 ea.) |
| 11. Air Injectors (6 ea.) | 27. Focus-Relief Jets (8 ea.) |
| 12. Suction Covers (4 ea.) | 28. Optional Integrated Charger |
| 13. Accu-Pressure™ Jets (6 ea.) | |
| 14. Weir Gate/Skimmer | |
| 15. Filter Lid | |
| 16. Waterfall Control Valve | |

Spa features subject to change without notice.

9.8 Cameo Massage/Waterfall Selector Diagram

Massage Selector Operation

Rotate Massage Selectors 1 and 2 to divert water between designated jet groups.

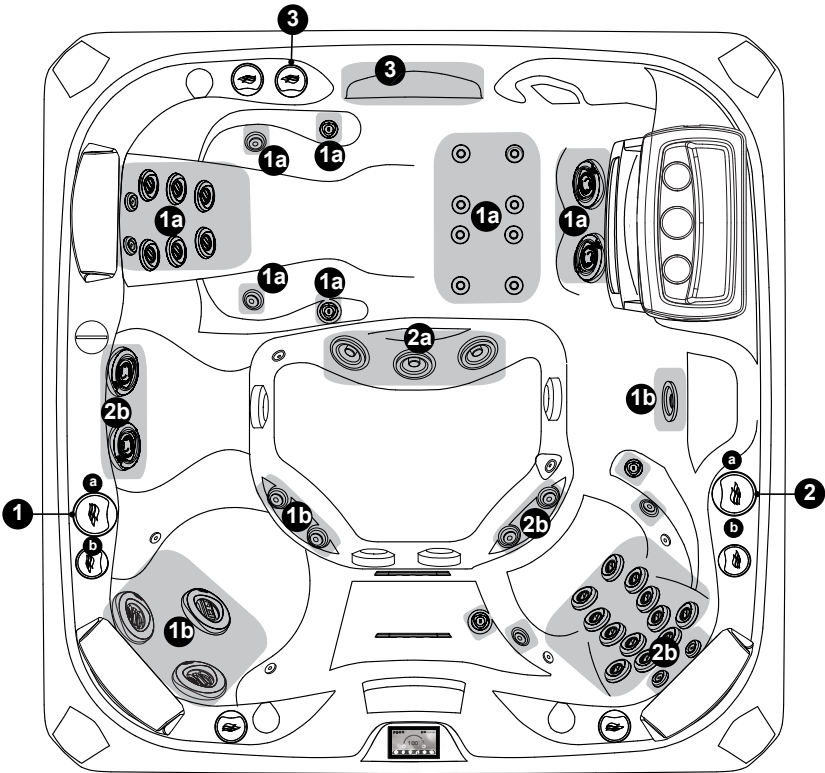

Massage Selectors (1-2)

- Massage Selector #1 controls pump #2.
- Massage Selector #2 controls pump #1.

Waterfall Selector (3)

- Waterfall Selector #3 controls circulation pump output to waterfall.

Spa operation subject to change without notice.

9.9 Cameo Air Controls Diagram

Air Control Operation

Rotate Air Controls 1-5 to add air to designated jet groups.
Turn the Blower on to add air to jets group 6.

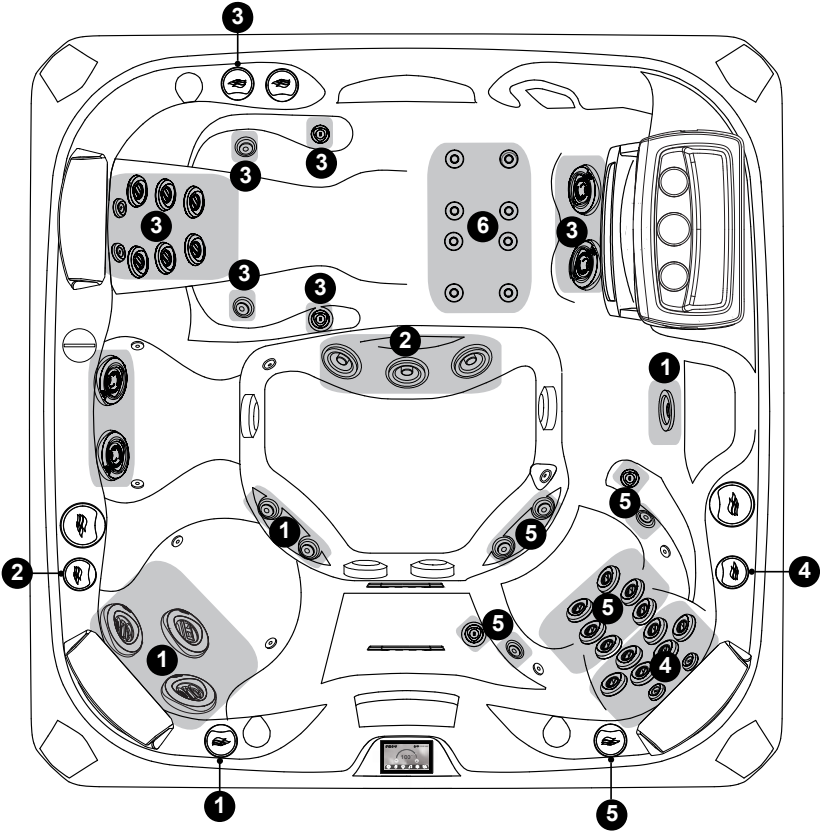

Spa operation subject to change without notice.

9.10 Altamar® Hot Tub Features

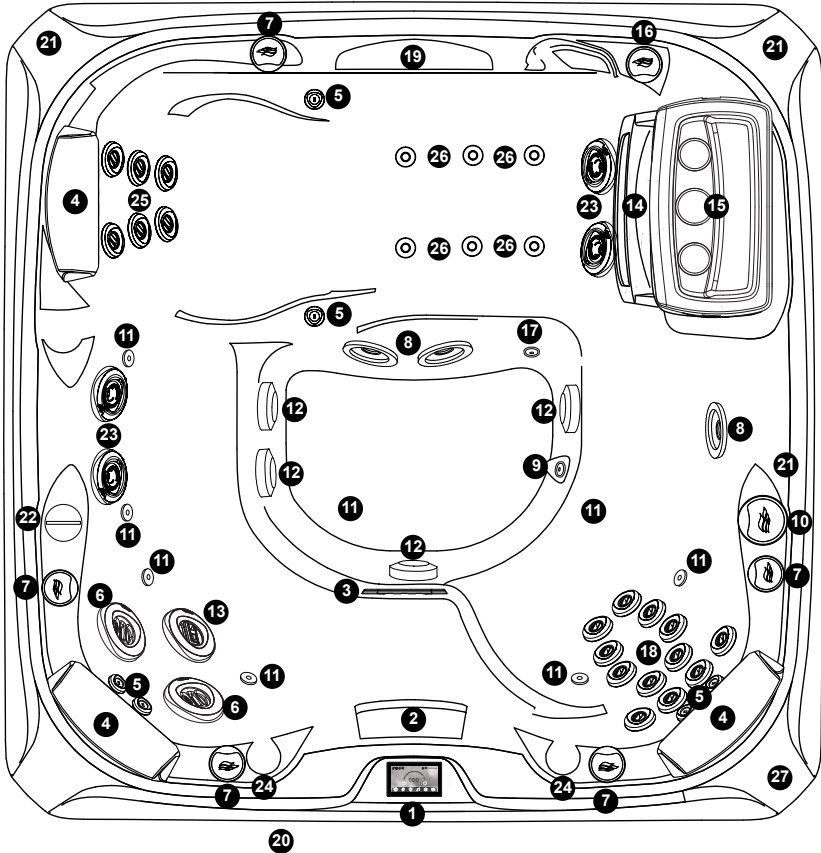

- | | |
|--|---|
| 1. Main Control Panel | 15. Filter Lid |
| 2. Handrail with LED Light | 16. Waterfall Control Valve |
| 3. Light | 17. Waterfall Filtration Return |
| 4. Pillows (3 ea.) | 18. Fluidix ST™ Jets (12 ea.) |
| 5. Fluidix Nex™ (6 ea.) | 19. Waterfall |
| 6. Fluidix Intelli-Jet™ (2 ea.) | 20. Optional BLUEWAVE® 2.0 Wireless Spa Stereo (behind cabinet) |
| 7. Air Controls w/LED Light (5 ea.) | 21. Optional Audio System Speakers (2 ea.) |
| 8. Whirlpool Jets (3 ea.) | 22. Sunscents Dispenser |
| 9. Gravity Drain | 23. Vortex™ Jets (4 ea.) |
| 10. Massage Selector | 24. Integrated Cupholders (2 ea.) |
| 11. Air Injectors (8 ea.) | 25. Fluidix Reflex™ (6 ea.) |
| 12. Suction Covers (4 ea.; one is not shown) | 26. Focus-Relief Jets (6 ea.) |
| 13. Fluidix PT™ Jet | 27. Optional Integrated Charger |
| 14. Weir Gate/Skimmer | |

Spa features subject to change without notice.

9.11 Altamar Massage/Waterfall Selector Diagram

Massage Selector Operation

Rotate Massage Selector 1 to divert water between designated jet groups.

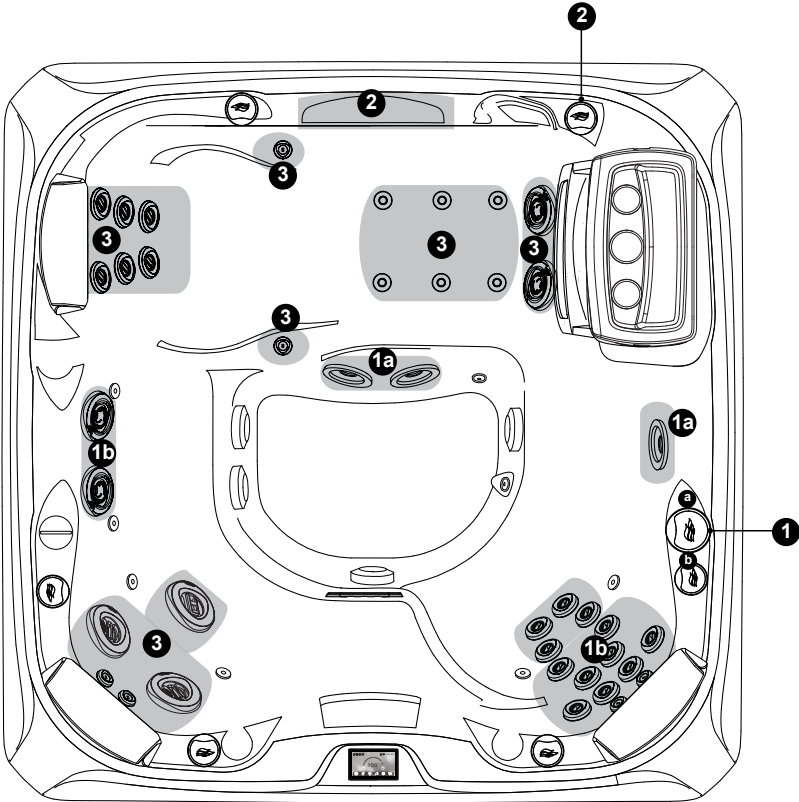

Massage Selectors (1)

- Massage Selector #1 controls pump #2.

Waterfall Selector (2)

- Waterfall Selector #2 controls circulation pump output to waterfall.

Continuously Powered Jets

- Jets #3 are always on when jets pump #1 is running.

Spa operation subject to change without notice.

9.12 Altamar Air Controls Diagram

Air Control Operation

Rotate Air Controls 1-5 to add air to designated jet groups.
Turn the Blower on to add air to jet group 6.

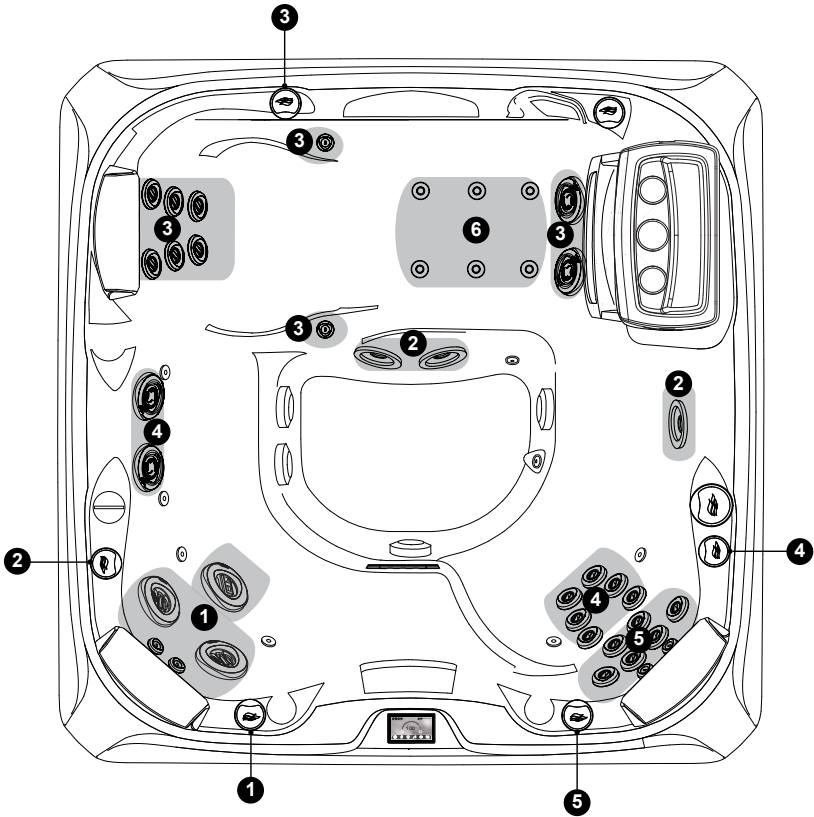

Spa operation subject to change without notice.

9.13 Vistamar® Hot Tub Features

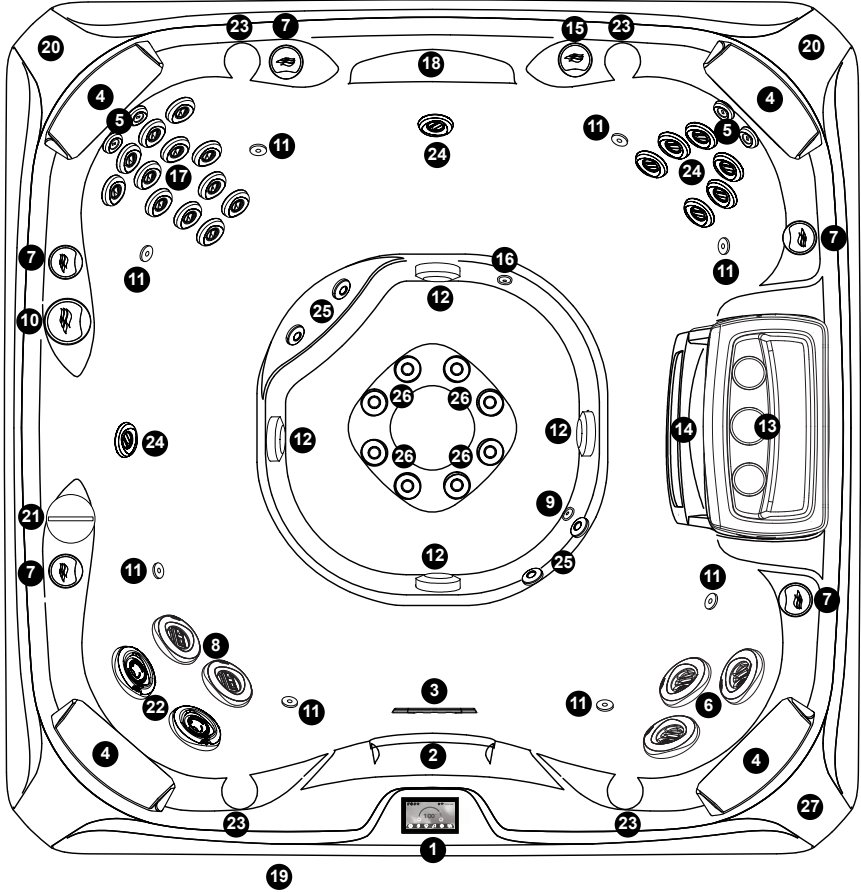

- | | |
|---|--|
| <ol style="list-style-type: none"> 1. Main Control Panel 2. Handrail with LED Light 3. Light 4. Pillows (4 ea.) 5. Fluidix Nex™ (4 ea.) 6. Fluidix Intelli-Jet™ (2 ea.) 7. Air Controls w/LED Light (5 ea.) 8. Fluidix PT™ Jets (2 ea.) 9. Gravity Drain 10. Massage Selector 11. Air Injectors (8 ea.) 12. Suction Covers (4 ea.; one is not shown) 13. Weir Gate/Skimmer 14. Filter Lid | <ol style="list-style-type: none"> 15. Waterfall Control Valve 16. Waterfall Filtration Return 17. Fluidix ST™ Jets (12 ea.) 18. Waterfall 19. Optional BLUEWAVE® 2.0 Wireless Spa Stereo (behind cabinet) 20. Optional Audio System Speakers (2 ea.) 21. Sunscents Dispenser 22. Vortex™ Jets (2 ea.) 23. Integrated Cupholders (4 ea.) 24. Fluidix Reflex™ (8 ea.) 25. Focus-Relief Jets (4 ea.) 26. Accu-Pressure Jets (8 ea.) 27. Optional Integrated Charger |
|---|--|

Spa features subject to change without notice.

9.14 Vistamar Massage/Waterfall Selector Diagram

Massage Selector Operation

Rotate Massage Selector 1 to divert water between designated jet groups.

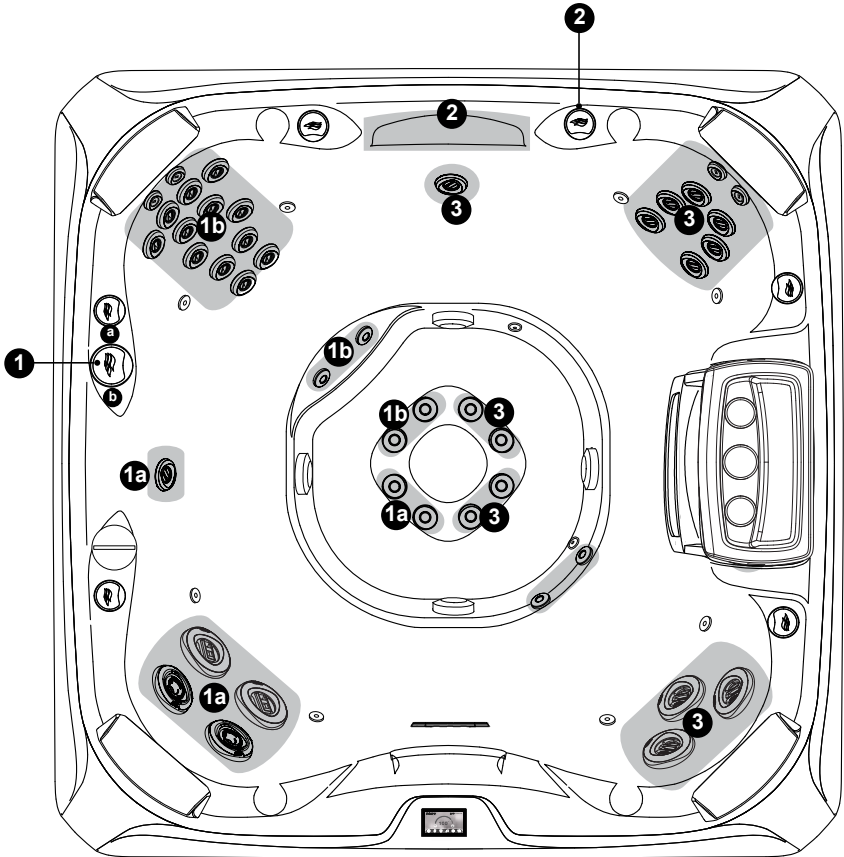

Massage Selectors (1)

- Massage Selector #1 controls pump #2.

Waterfall Selector (2)

- Waterfall Selector #2 controls circulation pump output to waterfall.

Continuously Powered Jets

- Jets #3 are always on when jets pump #1 is running.

Spa operation subject to change without notice.

9.15 Vistamar Air Controls Diagram

Air Control Operation

Rotate Air Controls 1-5 to add air to designated jet groups.
Turn the Blower on to add air to jets group 6.

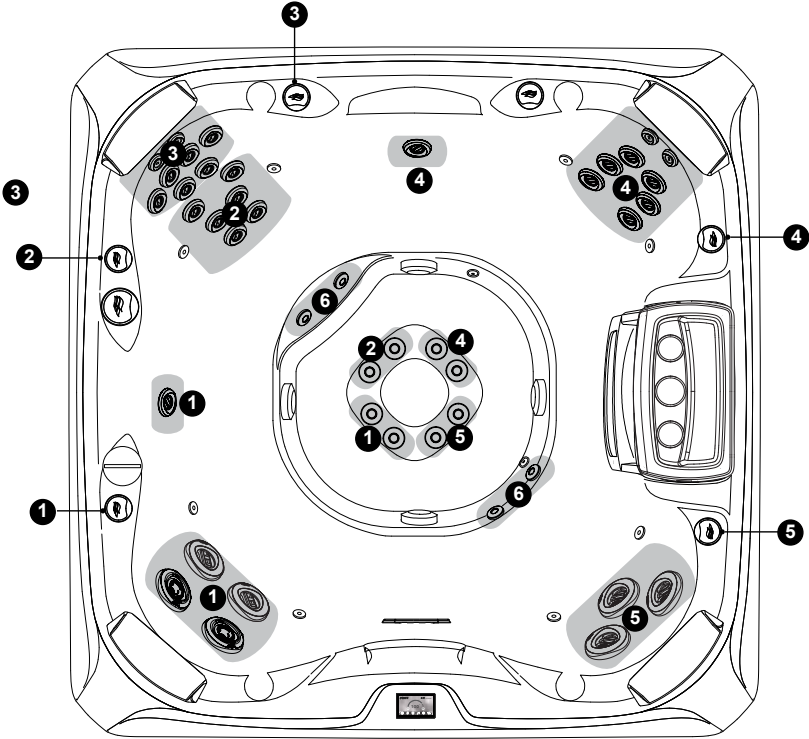

Spa operation subject to change without notice.

9.16 Marin® Hot Tub Features

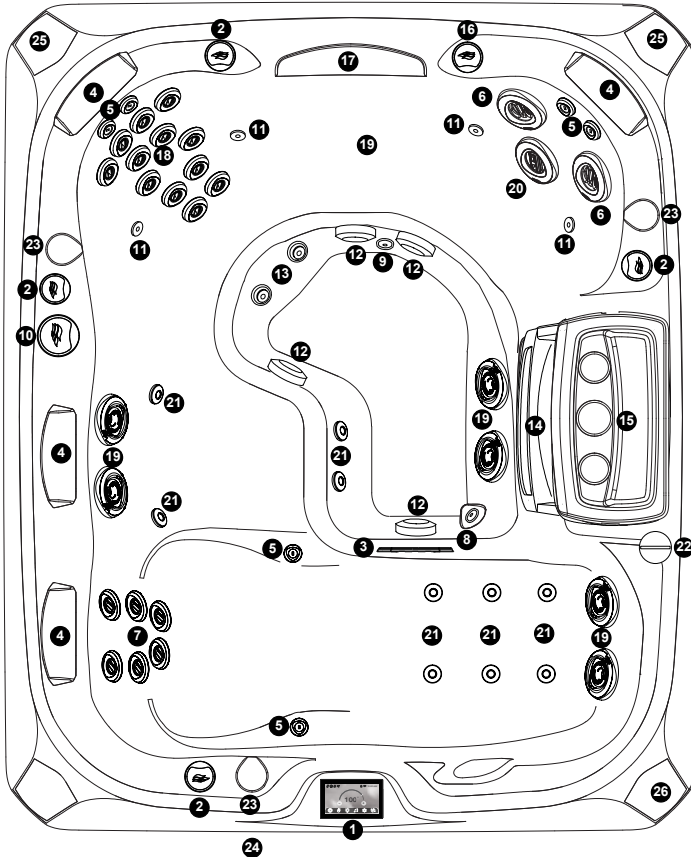

- | | |
|-------------------------------------|---|
| 1. Main Control Panel | 15. Filter Lid |
| 2. Air Controls w/LED Light (4 ea.) | 16. Waterfall Control Valve |
| 3. Light | 17. Waterfall |
| 4. Pillows (4 ea.) | 18. Fluidix ST™ Jets (12 ea.) |
| 5. Fluidix Nex™ (6 ea.) | 19. Vortex™ Jets (6 ea.) |
| 6. Fluidix Intelli-Jet™ (2 ea.) | 20. Fluidix PT™ Jet |
| 7. Fluidix Reflex™ Jets (6 ea.) | 21. Focus-Relief Jets (10 ea.) |
| 8. Gravity Drain | 22. Sunscents Dispenser |
| 9. Waterfall Filtration Return | 23. Integrated Cupholders (3 ea.) |
| 10. Massage Selector | 24. Optional BLUEWAVE® 2.0
Wireless Spa Stereo (behind
cabinet) |
| 11. Air Injectors (4 ea.) | 25. Optional Audio System Speak-
ers (2 ea.) |
| 12. Suction Covers (4 ea.) | 26. Optional Integrated Charger |
| 13. Accu-Pressure™ Jets (2 ea.) | |
| 14. Weir Gate/Skimmer | |

9.17 Marin Massage/Waterfall Selector Diagram

Massage Selector Operation

Rotate Massage Selector 1 to divert water between designated jet groups.

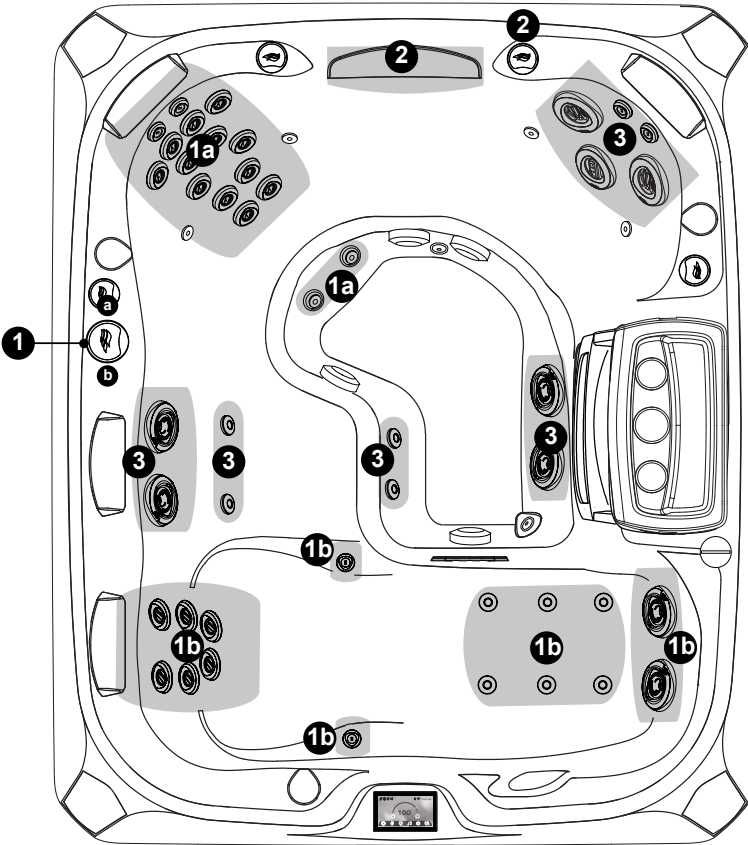

Massage Selectors (1)

- Massage Selector #1 controls pump #1.

Waterfall Selector (2)

- Waterfall Selector #2 controls circulation pump output to waterfall.

Continuously Powered Jets

- Jets #3 are always on when jets pump #2 is running.

Spa operation subject to change without notice.

9.18 Marin Air Controls Diagram

Air Control Operation

Rotate Air Controls 1-4 to add air to designated jet groups.
Turn the Blower on to add air to jets group 5.

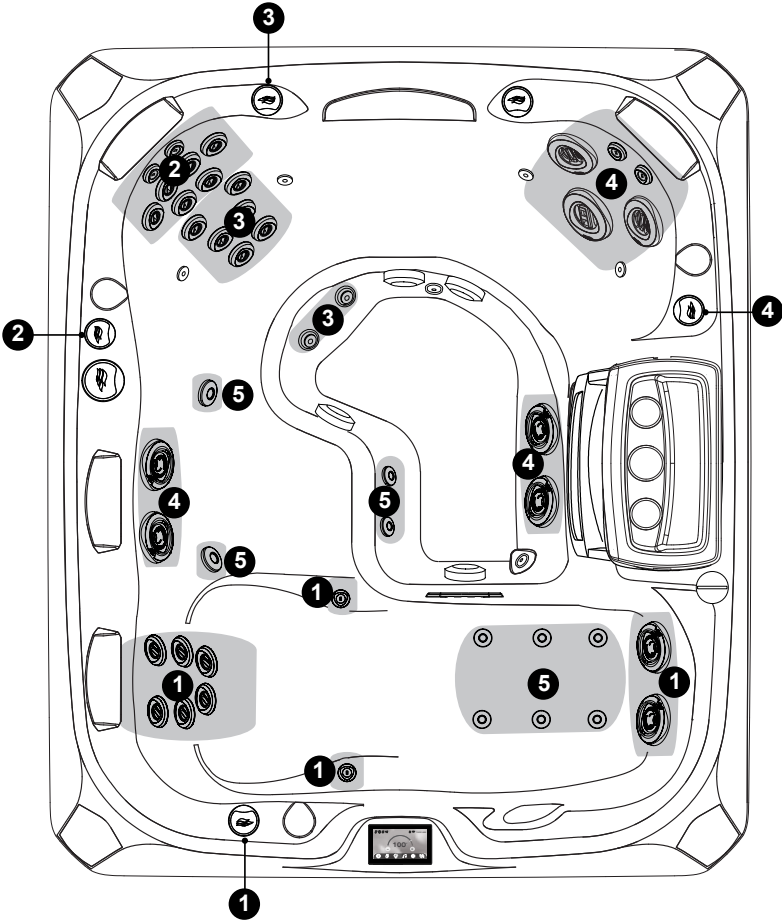

Spa operation subject to change without notice.

9.19 Capri® Hot Tub Features

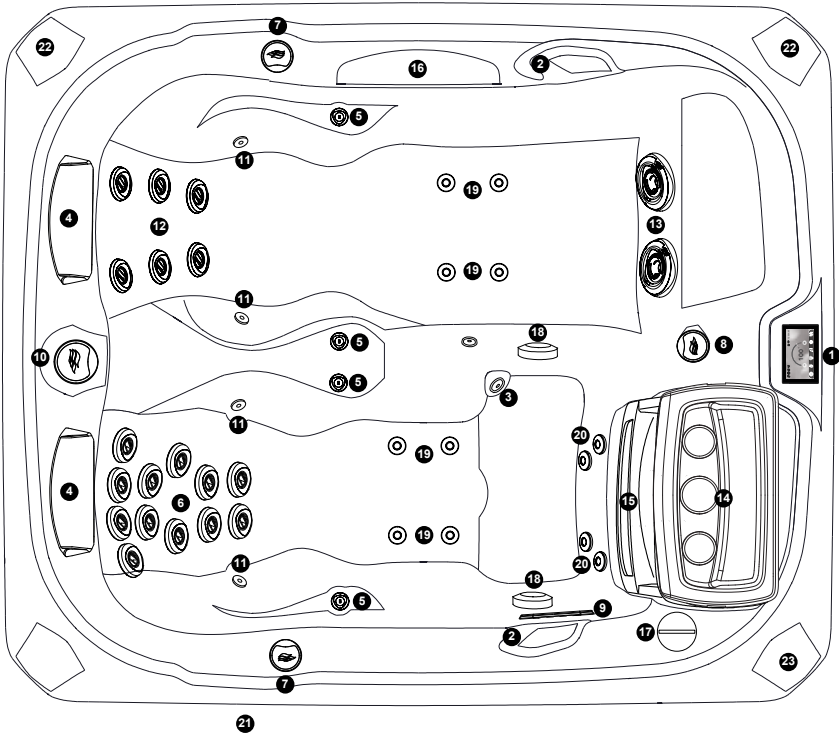

- | | |
|----------------------------------|--|
| 1. Control Panel | 14. Filter Lid |
| 2. Integrated Handrail (2) | 15. Weir Gate/Skimmer |
| 3. Gravity Drain | 16. Waterfall |
| 4. Pillows (3 ea.) | 17. SunScents Dispenser |
| 5. Fluidix Nex™ Jets (4 ea.) | 18. Footwell Suction Cover
(2 ea. one is not shown) |
| 6. Fluidix ST™ Jets (12 ea.) | 19. Focus-Relief Jets (4 ea.) |
| 7. Air Injectors (2 ea.) | 20. Accu-Pressure™ Jets (4 ea.) |
| 8. Waterfall Control Valve | 21. Optional BLUEWAVE® 2.0 Wire-
less Spa Stereo (behind cabinet) |
| 9. Light | 22. Optional Audio System Speakers
(2 ea.) |
| 10. Massage Selectors (2 ea.) | 23. Optional Integrated Charger |
| 11. Air Injectors (4 ea.) | |
| 12. Fluidix Reflex™ Jets (6 ea.) | |
| 13. Vortex™ Jet (2 ea.) | |

Spa features subject to change without notice.

9.20 Capri Massage/Waterfall Selector Diagram

Massage Selector Operation

Rotate Massage Selector 1 to divert water between designated jet groups.

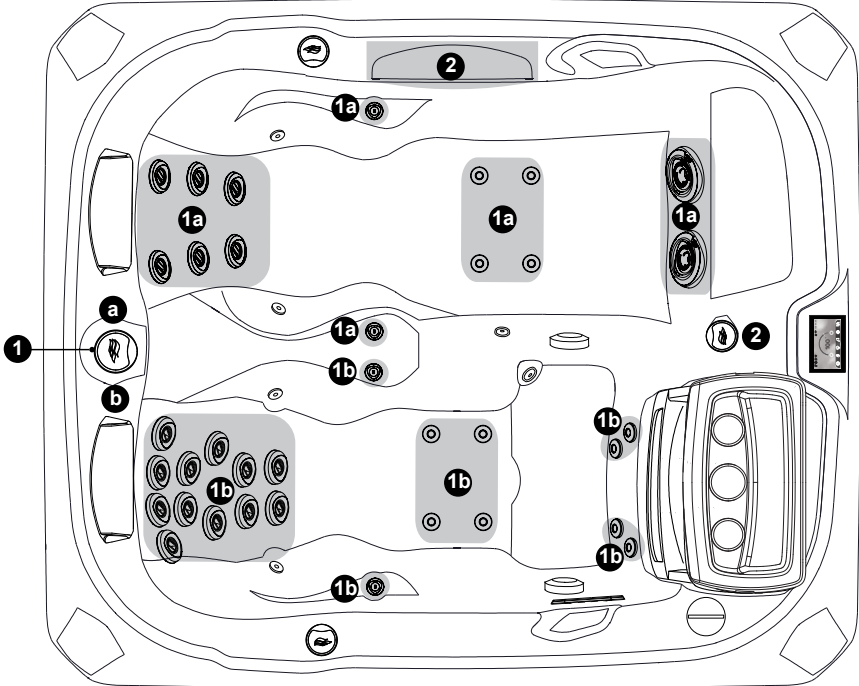

Massage Selectors (1)

- Massage Selector #1 controls pump #1.

Waterfall Selector (2)

- Waterfall Selector #2 controls circulation pump output to waterfall.

Spa operation subject to change without notice.

9.21 Capri Air Controls Diagram

Air Control Operation

Rotate Air Controls 1-2 to add air to designated jet groups.
Turn the Blower on to add air to jets group 3.

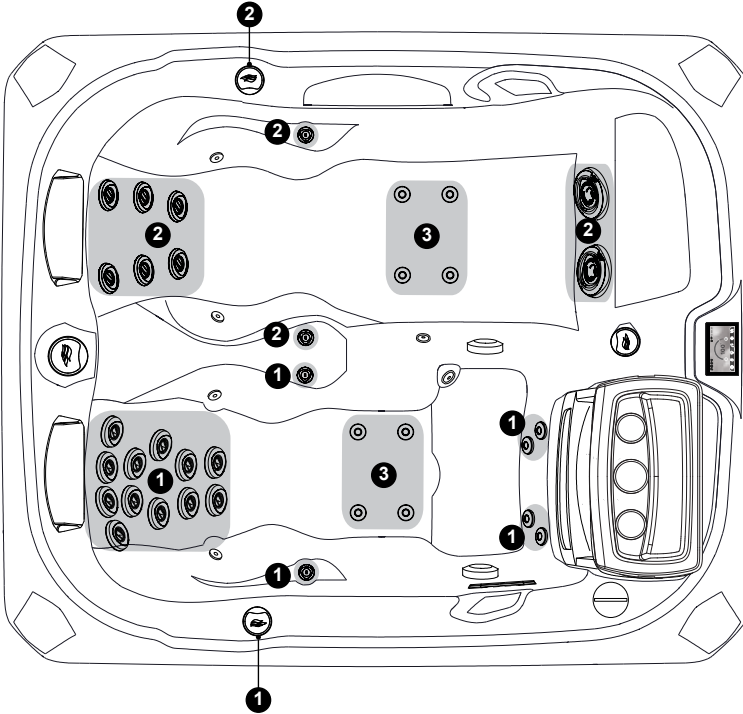

Spa operation subject to change without notice.

10.0 Registration and Start-up

10.1 Start-up Sequence

When power is first applied, the iTouch™ control panel will screens below will be displayed, Figures A. Then you will need to active the Priming Cycle, page 17.

Note: The start-up sequence will time out after approximately 20 seconds.

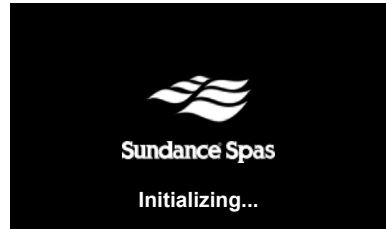
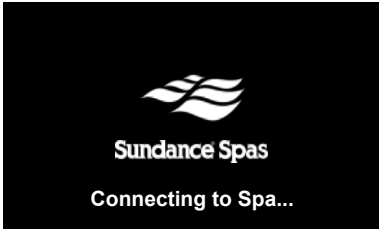

Figure A

10.2 Register Your New Spa

Registering your spa is important in order to validate your warranty. To register you will need to have the spa serial number, Figure B, then you will need to register online at www.SundanceSpas.com.

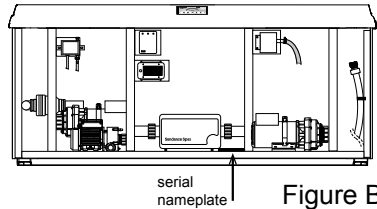

Figure B

Follow these steps to register your spa.

1. Using your home computer or other device, connect to the internet.
2. Go to www.SundanceSpas.com website to register your spa.
3. Click **Owner Resources**
4. Click **Warranty Registration**
5. Enter your serial number.
6. Click **Next** to continue to complete your registration.

10.3 iTouch™ Control Panel Main Menu

The new iTouch™ system makes operating your spa a breeze. The Home Menu, Figure A, provides access to spa functions and programming. You can navigate through the menus and sub-menus with ease. Simply touch the icons on the LCD display to begin operating your new Sundance spa. Operation is made easy by the interactive control panel.

Note: If there is no activity between 1 to 5 minutes, the LCD display, will time-out into a sleep mode. To reactivate the control panel, gently tap the display, see page 66.



A. Home Menu Control Buttons



Figure A



= **Temperature Control:** Allows you to adjust the set temperature of the spa:

- Increase or decrease the temperature by pressing the  or  buttons.

Note: The temperature range for the spa is 65 to 104°F (18.33 to 40°C). To activate the **Extended Temperature feature** that allows the spa to reach 106°F (41°C), see page 82.



= **Jet Button:** Tap to access the menu to operate the jets pumps and blower, page 42.



= **Light Button:** Tap to access the menu to operate the lighting options, page 47.



= **CLEARRAY Button:** Tap to activate the CLEARRAY on demand feature, page 50.



= **Settings Button:** Tap to access the programming and setting menus, page 55.













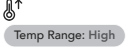

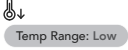

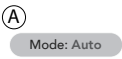
= **Music Button:** Tap to access the menu to operate the audio system and settings, page 48.

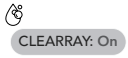
Note: If the spa does not have the stereo option, there will not be a button on the control panel.

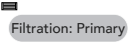

= **Invert Button:** Tap to invert the display image.

-  = **Error/ Reminder Indicator Icon:** Displays when there is an error or reminder message that needs to be addressed. The icon will also appear at the Home Menu as a reminder. Tap to view the condition that requires attention.
-  = **Information Icon:** Tap to display the information message.
-  = **Temperature High Range icon:** Indicates that the spa is set to high range temperature between 80°F (26.5°C) and 104°F (40°C). Tap the icon to display the information. 
-  = **Temperature Low Range icon:** Indicates that the spa is set to low range temperature between 65°F (18.5°C) and 99°F (37°C). 
-  = **Heat Mode Icon:** Indicates the heat mode that is activated. Tap to display information. 
-  = **CLEARARRAY® Icon:** Indicates that the CLEARARRAY is on. Tap to display information. 
-  = **Filtration icon:** Indicates that a filtration cycle is on. Tap to display information. 
-  = **CleanUp Cycle icon:** Will display when the CleanUp Cycle is on.
-  = **Lock Icon:** Displays when one of the lock modes is enabled, page 64.
-  = **Wi-Fi Icon:** Will display when if the optional SmartTub® system is installed.

12:00 PM = **Time Indicator:** The time will always be shown when the Home Menu is displayed. The appearance will vary depending on whether the clock is set to a 12-Hour or 24-Hour configuration, To Program the time see page 60. The default setting is 12-Hour.

Note: The time does NOT automatically adjust for daylight saving time. The time must be manually adjusted.

11.0 Operating Instructions

Your Sundance® Spas hot tub has a touch-sensitive control panel, massage selector valves and air control knobs located on the top rim of the hot tub (Sections 9.1-9.19, pages 22-40). These controls let you operate many of the special functions of your Sundance hot tub. By familiarizing yourself with the following information, you will be able to gain the full benefits afforded by the various functions of your hot tub.

11.1 Activating the Jets Pumps and Blower

From the Home Menu, (Figure A), tap  to enter the Submenu. The panel will display the Jets Pump Submenu (Figure B).

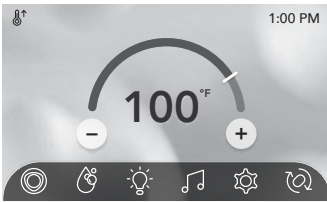

Figure A

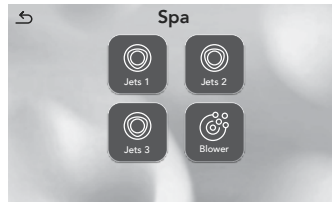

Figure B



= **Jets Pump 1 Button**



= **Jets Pump 2 Button (If equipped)**



= **Jets Pump 3 Button (If equipped)**



= **Blower Button**



= **Back Button:** Tap to go back to the Home Menu.

A. Jets Pumps

1. Tap the Jets 1 button to turn the pump on and off.
2. Tap the Jets 2 button to turn the pump on and off.
3. Tap the Jets 3 button to turn the pump on and off.

Note: Anytime a pump has been manually turned on, it will automatically turn off after approximately 20 minutes. If at this time you desire more jet operation you may simply turn the pump(s) back on.

B. Air Injection

Tap  to turn the blower on and off. The air blower forces air through the injectors and Focus-Relief Jets. The blower automatically turns off after 20 minutes. The jets might draw some air even though the blower is off.

11.2 Lights Menu

From the Home Menu, (Figure A), tap  to enter the Light Submenu. The LCD screen will display the Light Submenu (Figure B). From this menu you can control the hot tub lighting.

Note: The lights automatically turn off after 2 hours. They can be reactivated if needed.

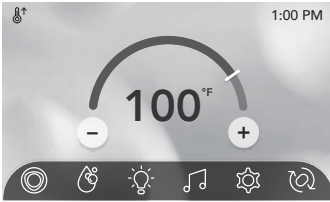

Figure A

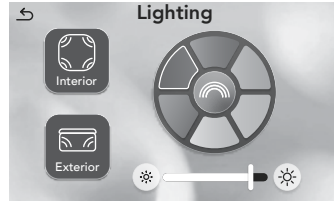





Figure B



= **Intensity Control:** Press or slide to activate and adjust the intensity of the lights. This will only work with the solid color option. The range is from off to 5. To turn off the lights, the intensity level must be decreased to off. Lights will default to last setting used.

- Tap  to raise the intensity of the lights to the maximum level of 5.
- Tap  to lower the intensity of the lights to the minimum level of off (.



= **Speed Control:** Controls the blending speed for the lights. The range is from off to x5.

- Tap  to increase or decrease the blending speed, of the colors.



= **Interior Light:** Press to activate the interior lights. The lights will default to the last setting used at a 100% intensity. The lights can also be turned on by selecting a color or pressing the high intensity button .



= **Exterior Light:** The exterior corner lighting has 2 settings. The lights display a solid White color only. By continually tapping the button you will scroll through the following:

- Press once, exterior lights are on at high intensity.
- Press again, exterior lights are on a timer. On at 7PM and off at 12AM everyday. Default intensity is high.
- Press a third time to turn off.

Note: The exterior lights automatically turn off after 8 hours, except for the timer setting.



= **Back Button:** Tap to go back to the Home Menu.



= **Color Selector:** Tap a color to select a single color.

11.3 Music Menu

Models equipped with the optional Audio System offer an enhanced spa experience. The BLUEWAVE® 2.0 Wireless Audio System works with most Bluetooth® wireless devices. An auxiliary device can be connected, via a 3.5 mm plug cable, located behind the front cabinet panel, if a Bluetooth device is not available. These models also include four high fidelity spa engineered speakers for unsurpassed sound quality and long-life, and an integrated powered subwoofer for a superb acoustical sound.

Note: If the spa does not have the stereo option, there will not be a button on the control panel.

To access the Music Menu, tap  Figure A. The display will change to Figure B. Once you enter the Music Menu, tap the power button to turn the stereo on. Your connected electronic device, Bluetooth or auxiliary, provides the audio entertainment.



WARNING: RISK OF ELECTRICAL SHOCK HAZARD EXISTS AND EQUIPMENT DAMAGE! Never install or remove electrical devices while hands are wet or while sitting partially immersed or fully immersed in spa!

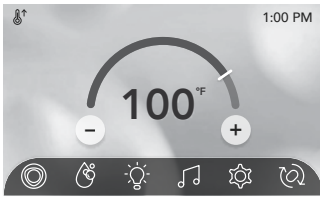

Figure A

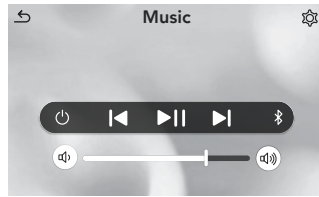

Figure B



= **Power Button:** Tap to turn the stereo on and off.



= **Bluetooth:** Allows a Bluetooth device to be connected with the stereo. Tap the icon to switch to Auxiliary.



= **Auxiliary:** Allows a Bluetooth device to be connected with the stereo. Tap the icon to switch to Bluetooth®.



= **Volume Up:** Tap or slide to increase the volume.



= **Volume Down:** Tap or slide to decrease the volume.



= **Forward:** Tap to advance forward through tracks.



= **Rewind:** Tap to move back through tracks.

 = **Pause/Play:** Tap to pause and play tracks.

Song Title = Song Title: Will display the song title information, if it is available. If the information is not available this part will be blank. If the information provided is too long, the maximum number of characters will be displayed follow by dots (“...”).



= **Audio Settings:** Tap to access the audio submenu, page 50. **Note:** Icon will not appear until the power button is pressed.



= **Back Button:** Tap to go back to the Home Menu.

11.4 Connecting the BLUEWAVE® System with your Bluetooth® device

A. To bridge a connection between the BLUEWAVE 2.0 Wireless Audio System and your Bluetooth® device, follow the steps below.

Note: The Bluetooth menu and Bluetooth connection will not display unless the optional audio system is available. If you experience a connection problem with your Bluetooth device, make sure that the Bluetooth antenna is secure and located at the highest point within the equipment bay.

1. Tap the music icon on the control panel screen then tap the power button.
2. From your Bluetooth device, make sure that the Bluetooth setting is ON.
3. Follow the pairing instructions for your Bluetooth device and connect to the “BLUEWAVE” device that appears on your screen.
4. Once the connection is established, the Bluetooth icon (📶) on the screen will be display confirming the connection.
5. If asked for a password, enter the password “0000” and then tap “Pair” on your device to connect.
6. If the pairing process is successful, your Bluetooth device will show “Connected” right next to “BLUEWAVE.”

B. Connecting an Auxiliary Device

1. Remove the front panel.
2. Locate the BLUEWAVE unit in the equipment bay.
3. Locate the cable labeled “AUX” that is connected to the unit.
4. Use a 3.5 mm cable (not included) to connect your auxiliary device.
5. Run the cable safely, through the front, and reinstall the panel.
6. Select the Auxiliary (🔊) option on the control panel, page 48.

Note: Use caution in handling the auxiliary device, the placement of the device, and that the cable is not in the way.

11.5 Audio Settings

To enter the Audio Settings, tap  from the Bluetooth® submenu, Figure A. The display will change to Figure B. The Audio Settings offer an enhanced audio experience by providing a custom or preset listening settings.

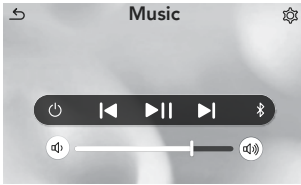

Figure A

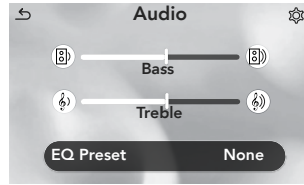

Figure B



= **Bass Selection:** Tap to adjust the bass setting to create a custom sound.



= **Treble Selection:** Tap to adjust the treble setting to create a custom sound.



Bass

=

Bass/Treble Adjustment Bars: Tap the Bass or Treble buttons or slide the bar to adjust the settings. This feature can be used to create a custom sound.

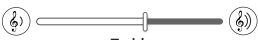

Treble



=

EQ Preset: Tap to activate the Rock, Pop or Classical preset audio settings.



= **Back Button:** Tap to go back to the Home Menu.

11.6 CLEARARRAY on Demand

The CLEARARRAY on demand feature activates the water purification system. Continuously tap  to activate the system for 1 hour, 2 hours, 3 hours or OFF. During this time the circulation pump and the CLEARARRAY Active Oxygen™ system are on.

Note: When the CLEARARRAY Active Oxygen™ system is on due to a programmed or scheduled setting the feature cannot be turned off.

11.7 Ozone Operation

The Ozonator will activate anytime the circulation pump is on during the Primary Filter Cycle or heat call.

Note: Do not press either JETS button, this will shut off the ozone for the amount of time the jets are on plus 5 minutes after they shut off.

11.8 Selecting The Desired Massage Action

Your Sundance® Spas hot tub is equipped to allow you to customize the massage action you desire. Each model incorporates a massage selector(s) that allows you to customize the massage and performance by diverting water between various jet systems. Simply turn massage selector to position A (Combo), B, or C to divert water pressure to various jet groups.



Note: This valve is designed to operate in positions A (Combo), B, and C for optimum performance. It is considered normal for sound levels within the valve to vary between positions due to the large amounts of water flowing through it. For optimum filtration benefits, leave the valve in position A when hot tub is covered. Select position B or C for maximum jet performance during hot tub use.

11.9 Adjusting Fluidix Reflex™, Nex™, ST™, Intelli-Jet™ And Focus-Relief®

The jets in your new hot tub offer the advantage of no moving parts and zero maintenance. They can also be adjusted for a high and low impact massage, providing the ultimate massage! To adjust jets:

Note: Always keep at least 6 adjustable jets open at all times on each jet system.

1. Fluidix Nex/Intelli-Jets, and Reflex Jets only: Turn outer dial (A) clockwise to increase water volume. Turn outer dial counterclockwise to decrease water volume or to shut jet off.
2. Fluidix Intelli-Jet only: Rotate center “mode disk” clockwise to select a non-oscillating water stream or turn counterclockwise to select an oscillating stream at any angle.
3. Fluidix PT Jet: Rotate center “mode-disk” counter or clockwise 360 degrees to change output direction of jet stream.
4. For a high impact massage, turn corresponding air control knob clockwise. For the Fluidix ST jet, this will create a straight water flow. For low impact massage, turn corresponding air control knob counterclockwise. For the Fluidix ST jet, this will create an oscillating flow. The included tool (shown) allows you to position the jet nozzle angle to your liking. This tool can also be used to aid in the opening or closing of the nozzle on Fluidix Reflex jets.
5. Focus-Relief Jets: Work with both the blower and jets pump. The blower introduces air to the jet and the jets pump forces water through. The jets might draw some air even though the blower is off.



Fluidix Intelli-Jet



Fluidix Reflex Jet



Fluidix PT Jet



Fluidix ST Jet



Fluidix Reflex Jet



Focus-Relief Jet

11.10 Air Controls

Each jet system has its own air control. These controls allow you to regulate the amount of air which is mixed with the water entering through the jets. Clockwise rotation adds more air and counterclockwise rotation reduces air flow.



Note: To minimize heat loss, close all air controls when spa is not in use. Certain jets may draw air even though they are closed. This is considered normal.

11.11 Waterfall Control

Turn waterfall control valve counterclockwise to increase waterfall(s) output. Turn control valve clockwise to decrease or turn off waterfall(s) output. The waterfall is on when the circulation pump is running.



Note: It takes 2 full revolutions to change the waterfall from a full off to a full on flow rate. When the waterfall is in the OFF position some water may still flow through. This is considered normal.

11.12 Fragrance Dispenser

On the rim of your hot tub is a screw-off cap labeled “SunScents™ Fragrance Dispenser” (pages 22-40). It is designed to contain packages of a specially made fragrance available from your Sundance Spas dealer. The fragrance is carried into the hot tub water by the air coming through the injector system when the air blower is on.



WARNING: TO DECREASE RISK OF PERSONAL INJURY.

- Always turn off the air blower before removing or installing SunScents dispenser cap to reduce the risk of by having the dispenser and/or cap fly up.
- Use only Sundance SunScents fragrances in your new hot tub, as the tub has not been tested for use with any other manufacturer. Never use this dispenser for any other type of fragrance.
- Install basket directly into SunScents dispenser.
- **Always make certain that the dispenser cap is securely in place before operating the hot tub’s air blower, to avoid the cap from flying off when the blower is activated.**

11.13 MicroClean® Plus Versatile Filter Lid

The multi-purpose filter lid can be used as cooler or as a seat (with the optional aftermarket seat cushion; maximum weight capacity of 300 lbs).



IMPORTANT! If liquids (other than water) spill, take all precautions to prevent contaminants from entering and affecting the hot tub water.

11.14 Optional SmartTub® System

Advances in technology have allowed us to create a better and smarter hot tub. Our SmartTub® system operates on a cellular network. The advantages of this system are:

- A more stable connection to internet for outdoor environment. The SmartTub® device uses much less data than a typical voice connection via cellular networks. We contract through the largest wireless carriers to ensure maximum uptime. The system enables firmware updates via the cell connection so your system's performance will continuously be optimized remotely.
- Maintenance is made easy by alerts sent to your phone.
- Diagnostic alerts are sent to you and your dealer when attention is required.

A. Pairing process

1. Download the SmartTub® app from the Google Play store or Apple App store.
2. Open the app and create an account.
3. Locate the SmartTub® sticker next the control panel of the hot tub. You can either scan the QR code with the SmartTub® app or manually input the serial number located below the QR code on the sticker.
4. After you pair the hot tub's serial number to the SmartTub® app, the app will load and connect the hot tub to the internet.
5. Follow the instructions on the app to begin enjoying the benefits of your internet connected hot tub.

Note: The first year of data service is included. You will need to renew the subscription after the first year. Please refer to the terms of service and privacy policy links in the SmartTub® app for additional information.

B. Indicator Lights

There are indicator lights on the SmartTub® controller that relay the status of the system. Below are meanings of the lights.

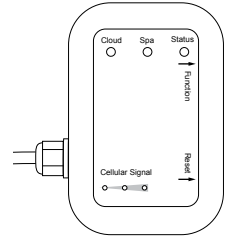

1. Cloud:
 - Blue light on - connected to cloud.
 - Blue light off - not connected to cloud.
2. Spa:
 - Blue light on - connected to spa controller
 - Blue light off - not connected to spa controller
3. Status:
 - Cyan light - breathing (slow pulsing) indicates the status is good.
 - Cyan light - flashing indicates that the system is completing a connection to the cloud.
 - Green light - flashing indicates waiting for a connection to the cellular tower.
 - Dark blue light - flashing indicates a SIM error.
4. Cell signal strength:
 - 3 blue LED lights indicates cell signal strength.

C. Resetting the SmartTub® controller

Should the SmartTub® controller need to be reset, hold a magnet to the reset label on the side of the SmartTub device.

12.0 Programming and Operation Instructions

Your Sundance spa is equipped with setting menus that allow you to program and activate different components of the spa. With our iTouch™ control panel, programming your spa has never been easier. In the sections that follow, we will guide you through the process of programming the spa to fit your personal comfort. From the Home Menu, tap  to enter the Settings Menus, Figures A and B.

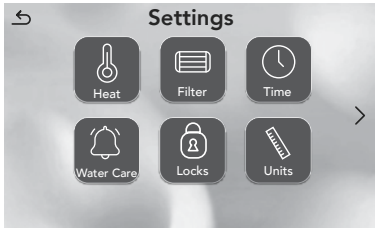

Figure A

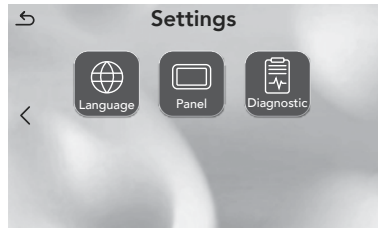

Figure B



= **Heat:** Provides access to the heating programming, page 56.



= **Filter:** Provides access to the filtration programming, page 56.



= **Time and Date:** Provides access to the time and date programming, page 60.



= **Water Care:** Provides access to the water care programming, page 61.



= **Lock:** Provides access to activate the locking features, page 64.



= **Units:** Allows access to the temperature and time display feature, page 65.



= **Language:** Provides access to the language programming, page 66.



= **Panel:** Provides access to the sleep and wake programming of the control panel, page 56.



= **Diagnostic:** Provides access to the hot tub information, page 56.



= **Back Button:** Tap to go back to the previous Menu.

12.1 Programming the Heat Settings

Your Sundance spa is equipped with 3 modes of heating. An automatic mode called “Auto” where the spa’s temperature is always maintained. An energy saving heating cycle called “Economy.” A mode that will only activate the heater during the daytime called “Day” mode.

Note: The heater will activate when the temperature drops 1°F (0.5°C) from the set temperature.

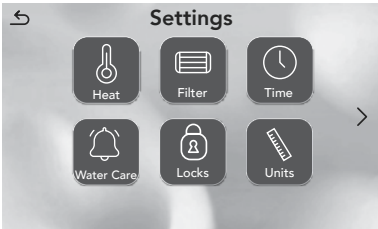

Figure A

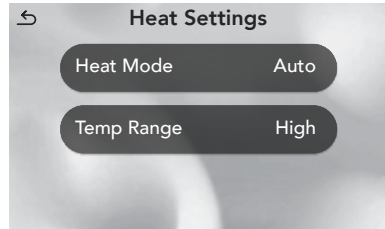





Figure B

Heat Mode:

From the Settings Menu, tap  to enter the Heat Settings submenu, Figure A. Tap  to enter the menu, Figure B. Then scroll to select one of the heating settings, Figure C.

A. **Auto heating:**

1. When programmed to Auto, the spa will maintain the water temperature to the set temperature. Heating will occur when necessary.
2. To select this mode, highlight the Auto tab and press the set button .

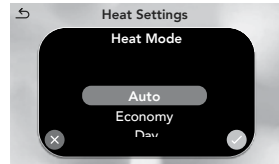



Figure C

B. **Economy heating:**

1. This is an energy saving heating program that allows the spa to heat during non-peak hours. When programmed to Economy, the spa will only be allowed to heat the water between 5:00 PM to 7:00 AM every day of the week. The hours cannot be adjusted.
2. To select this mode, highlight the Economy tab and press the set button .

C. **Day heating:**

1. When programmed to Day, the spa will only be allowed to heat the water between 7:00 AM to 5:00 PM every day of the week. The hours cannot be adjusted.
2. To select this mode, highlight the Day tab and press the set button .

Temp Range:

Tap  to switch between a High Range or Low Range temperature setting. The default setting is High Range. When you tap the temp range icon, on the Main Menu, it will display the current range setting, Figure D.

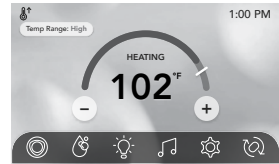



Figure D

A. High Range Temperature (default setting)

The high range temperature can be set between 80°F (26.5°C) and 104°F (40°C). When the spa is in this setting it will display this icon  on the upper left corner of the control panel. The hot tub cannot be set to a temperature below 80°F (26.5°C).

B. Low Range Temperature

The low range temperature can be set between 65°F (18.5°C) and 99°F (37°C). When the spa is in this setting it will display this icon  on the upper left corner of the control panel. The hot tub cannot be set to a temperature above 99°F (37°C).

12.2 Programming the Primary Filter

To access the Primary Filter settings, tap  from the Settings menu, Figure A, to enter the Filtration programming, Figure B.

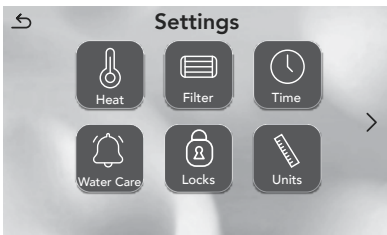

Figure A

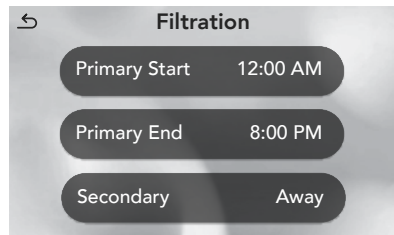

Figure B

During a primary filtration, the circulation pump and the CLEARRAY Active Oxygen™ system are activated. The factory default cycle starts at 12:00 AM and last for 8 hours. If you elect to keep this setting, then you can skip this section.



In extreme bitter cold weather, where freezing can occur, we recommend you program the circulation pump to run 24 hours. Refer to the “Winterizing” section on page 73.

Any time the circulation pump runs outside of a program cycle, e.g. for heating, that run time will be deducted from the next primary filter cycle. For example, the primary filter cycle is set to 8 hours every 24 hours but the circulation pump comes on for 2 hours to heat the water after the cycle has finished. The next primary filter cycle will only be for 6 hours not 8 hours.

A. To change the default cycle:

Tap **Primary Start 12:00 AM** to enter the menu. When you enter the menu, certain icons will be highlighted, Figure C.

Note: If **X** is pressed, in the middle of programming, it will clear the changes made and revert to the prior programmed settings. This feature can be used to make corrections.

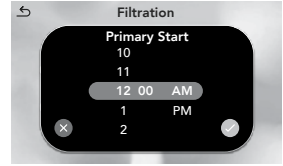

Figure C

1. Scroll through the first column to change the hour in 1-hour increments.
2. Select AM or PM. This can also be changed when you round a 12-hour period.
3. Tap **✓** to accept and save the change.
4. Tap **Primary End 8:00 PM** to program the end time for the cycle, Figure D.

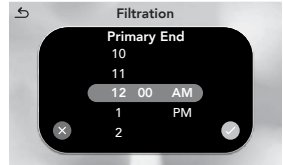

Figure D

5. Scroll through the first column to change the hour in 1-hour increments.
6. Select AM or PM. This can also be changed when you round a 12-hour period.

Summer Logic: In warm weather, the water temperature in the spa may exceed the set temperature. This condition may occur due to heat transference from the filter/circulation pump and jets pumps. If the water temperature is higher than 95°F (35°C) and rises 2°F above the set temperature, a “Summer Logic” condition occurs that deactivates the filter/circulation pump, CLEARRAY Active Oxygen™ system and secondary filtration. This safety feature cannot be altered! They will remain off until the water temperature cools to the set temperature (except when the filter/circulation pump runs for its mandatory 3-hour cycles between 8am-11am and 8pm-11pm.) To help prevent a “Summer Logic” condition, it may be necessary to reduce filter/circulation pump cycles run times in warm weather.

12.3 Programming the Secondary Filter

To access the Secondary Filter, tap **Secondary Away** from the Filtration Menu, Figure A, to enter the Secondary Filter programming, Figure B.

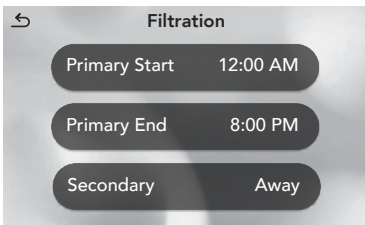

Figure A

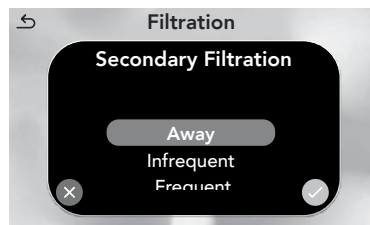



Figure B

During a secondary filtration, the Jets Pump 1 is activated. There are 3 cycles you can select from, Figure B. The factory default cycle is “Away Mode.” If you elect to keep this setting, then you can skip this section.

A. To change the Secondary Filter cycle:

1. Away Mode: Secondary Filtration is disabled. To activate this mode, tap the “Away” tab. This is the factory default setting.
2. Infrequent Mode: Activates two cycles at 8:00 PM and 8:00 AM **every other day**. Each cycle will last 10 minutes for a total of 20 minutes every other day. To activate this mode, tap the “Infrequent” tab. Time and duration cannot be altered.
3. Frequent Mode: Activates two cycles at 8:00 PM and 8:00 AM **every day**. Each cycle will last 10 minutes for a total of 20 minutes every day. To activate this mode, tap the “Frequent” tab. Time and duration cannot be altered.
4. Tap  to accept and save the change.
5. Tap  to return to the Settings Menu. Tap again to return to the Main Menu.

12.4 Cleanup Cycle

The cleanup cycle occurs once per day at 12:00 pm (noon). This is not user programmable. Turning off the corresponding jets pump that is running can deactivate the feature.

- One Pump System - Jets Pump 1 and the blower turn on for 1 minute and then shut off.
- Two Pump System - Jets Pump 1 and the blower turn on for 1 minute and then shut off. Then Jets Pump 2 turns on for 1 minute and then shuts off.
- Three Pump System - Jets Pump 1 and the blower turn on for 1 minute and then shut off. Then Jets Pump 2 turns on for 1 minute and then shuts off. Then Jets Pump 3 turns on for 1 minute and then shuts off.

12.5 Programming the Time and Date

From the Settings Menu, tap  to enter the programming options, Figures A and B.

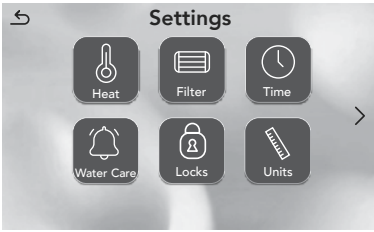

Figure A

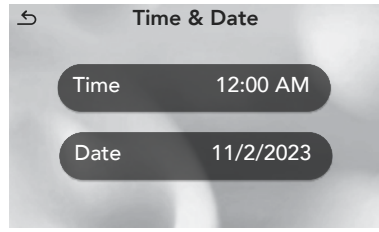



Figure B

A. To set the time:

The default time setting is a 12-hour configuration. To choose the 24-hour configuration see page 65. Tap  to enter the menu, Figure C.

1. Scroll through the first column to change the hour in 1-hour increments.
2. Scroll through the second column to adjust the minutes.
3. Select AM or PM. This can also be adjusted when you round a 12-hour period.
4. Tap  to accept and save the change.

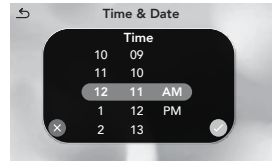

Figure C

B. To set the date:

Each setting for month, day and year can be set independently, Figure D.



1. Scroll through the first column to select the month.
2. Scroll through the second column to select the day.
3. Scroll through the third column to select the year.
4. Tap  to accept and save the change.
5. Tap  to return to the Settings Menu. Tap again to return to the Main Menu.



Figure D

12.6 Water Care Programming

Water care is crucial to maintaining a clean spa. The CLEARRAY Active Oxygen™ system leads the way to a clean* spa by using a UV light bulb and ozone. Your spa can be programmed to remind you when to check and replace certain components.

From the Settings Menu, tap  to enter the Water Care Menu, Figures A and B. Then select one of the features.

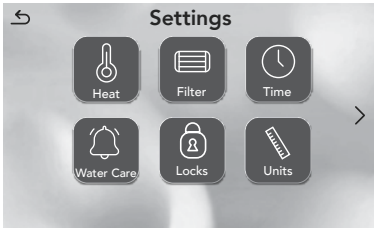

Figure A

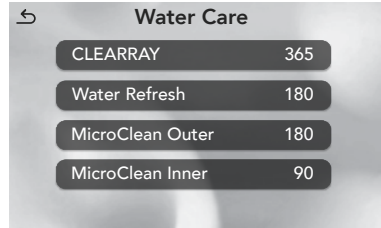



Figure B

A. Programming the CLEARRAY UV Bulb Timer

The CLEARRAY UV bulb has a life expectancy of 1 year. A timer activates when power is applied and begins a countdown starting at 365 days. Once the timer expires, an reminder message will appear on the display, the UV bulb must be replaced and the timer needs to be reset. Tap  to enter the Programming Menu.

Note:

- The days are stored in memory if the power is interrupted.
- The CLEARRAY UV timer counts down by days not usage.

1. From the Water Care Menu, you can set the CLEARRAY UV bulb timer, Figure C.
2. Scroll through the column to change the days in 10-day increments. The range is from OFF (- - -) to 365 days. It is not recommended that this feature be turned OFF. In order to continually have the CLEARRAY system effectively perform its function, it should be program as instructed.

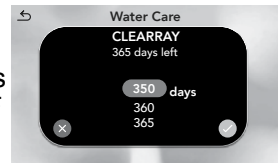







Figure C

Note: Pressing  will clear current changes made. The days will revert to the previous programmed setting. This feature can be used to make corrections.

3. Tap  to accept and save the change. The display will revert to the Water Care Menu.
4. Tap  to return to the Water Care Menu. Tap again to return to the Settings Menu.

*Clean is defined as the removal of microscopic (to 30 µm level) debris from the water. Ozone aids in the grouping of small debris. Once combined, the debris can be more easily caught by the filtration process.

- When the timer expires, a message will appear on the control panel display. The CLEARRAY UV bulb **must be replaced** (page 76) and the timer must be reset. Tap  and follow the instructions above to reset the timer. If you tap  the message will clear but the reminder icon  will display and the message will reappear in 10 days.

B. Programming the Water Refresh Timer

A programmable Water Refresh reminder can be set to remind you when to drain and refill the spa. Tap  (Figure B) to enter the Programming Menu.

- From the Water Care Menu, you can set the Water Refresh timer, Figure D.
- Scroll through the column to change the days in 30-day increments. The range is from OFF (- - -) to 180 days. It is not recommended that this feature be turned OFF. In order to continually maintain the water healthy and clean, in addition to chemical maintenance, it should be program as instructed.

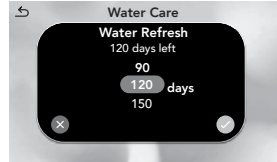





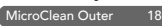

Figure D

Note: Pressing  will clear current changes made. The days will revert to the previous programmed setting. This feature can be used to make corrections.

- Tap  to accept and save the change. The display will revert to the Water Care Menu.
- Tap  to return to the Water Care Menu. Tap again to return to the Settings Menu.
- When the timer expires, a message will appear on the control panel display. The water must be drained and replaced with fresh water. Tap  and follow the instructions above to reset the timer. If you tap  the message will clear but the reminder icon  will display and the message will reappear in 10 days.

C. Programming the MicroClean® Outer Filter Timer

A programmable filter timer can be set to remind you when to clean or replace the MicroClean Outer Filter. Tap  (Figure B) to enter the Programming Menu.

- From the Water Care Menu, you can set the MicroClean Outer timer, Figure E.
- Scroll through the column to change the days in 10-day increments. The range is from OFF (- - -) to 180 days. It is not recommended that this feature be turned OFF. In order to continually maintain clean and working filters, it should be program as instructed.

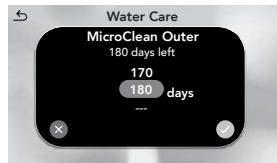









Figure E

Note: Pressing  will clear current changes made. The days will revert to the previous programmed setting. This feature can be used to make corrections.

3. Tap  to accept and save the change. The display will revert to the Water Care Menu.
4. Tap  to return to the Water Care Menu. Tap again to return to the Settings Menu.
5. When the timer expires, a message will appear on the control panel display. The filter must be cleaned or replaced. Tap  and follow the instructions above to reset the timer. If you tap  the message will clear but the reminder icon  will display, and the message will reappear in 10 days.

D. Programming the MicroClean® Inner Filter Timer

A programmable filter timer can be set to remind you when to replace the MicroClean Inner Filter. Tap  (Figure B) to enter the Programming Menu.

1. From the Water Care Menu, you can set the MicroClean Inner timer, Figure F.
2. Scroll through the column to change the days in 10-day increments. The range is from OFF (- - -) to 90 days. It is not recommended that this feature be turned OFF. In order to continually maintain clean and working filters, it should be program as instructed.

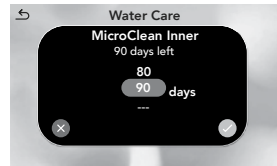









Figure F

Note: Pressing  will clear current changes made. The days will revert to the previous programmed setting. This feature can be used to make corrections.

3. Tap  to accept and save the change. The display will revert to the Water Care Menu.
4. Tap  to return to the Water Care Menu. Tap again to return to the Settings Menu.
5. When the timer expires, a message will appear on the control panel display. The filter must be replaced. Tap  and follow the instructions above to reset the timer. If you tap  the message will clear but the reminder icon  will display and the message will reappear in 10 days. Refer to Section 13.1, page 68, for filter location.

12.7 Locking the Spa

From the Settings Menu (Figure A), tap  to enter the programming options, Figure B. You can prevent users from changing certain features of the spa. When a lock feature is active, the lock icon  will appear on the Main Menu.

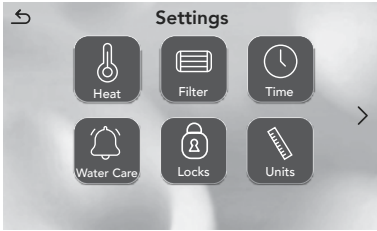

Figure A

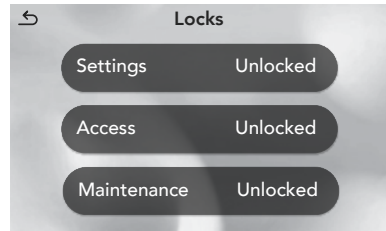





Figure B

A. Settings Lock (Figure C):

1. Tap  to enter the lock feature.
2. Scroll through each column to select a number. Then move on to the next number until a four-digit code has been selected.
3. Tap  to accept and save the change. The display will revert to the Locks Menu.
4. The Settings Menu and all its functions are disabled, but the spa will still perform all scheduled tasks.
5. Tap  to return to the Settings Menu. Tap again to return to the Main Menu.

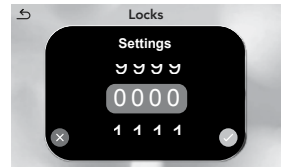





Figure C

B. Access Lock (Figure D):

1. Tap  to enter the lock feature.
2. Scroll through each column to select a number. Then move on to the next number until a four-digit code has been selected.
3. Tap  to accept and save the change. The display will revert to the Locks Menu.
4. All activation and adjustment features are disabled but the spa will still perform all scheduled tasks.
5. Tap  to return to the Settings Menu. Tap again to return to the Main Menu.

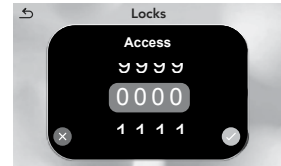
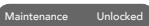



Figure D

C. Maintenance Lock (Figure E):

1. Tap  to enter the lock feature.
2. Scroll through each column to select a number. Then move on to the next number until a four-digit code has been selected.
3. Tap  to accept and save the change. The display will revert to the Locks Menu.
4. All spa functions are locked to allow for a temporary service mode such as filter cleaning.

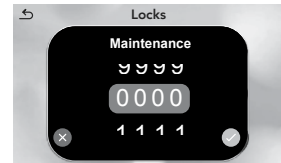





Figure E

- Tap  to return to the Settings Menu. Tap again to return to the Main Menu.

Note: This mode has a time out of 2 hours. The spa should not be left in this lock mode for an extended period. Especially in colder climate or when freezing conditions exist.

D. To Unlock (Figure F):

- Enter the Lock menu. Select the tab for the features to unlock: settings, access or maintenance.
- Scroll through each column to select a number. Then move on to the next number until a four-digit code has been entered.
- Tap  to accept the code. The display will revert to the Locks Menu.
- Tap  to return to the Settings Menu. Tap again to return to the Main Menu.

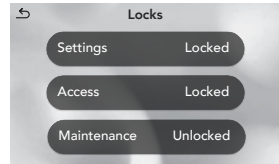

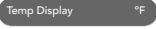



Figure F

Note: A default passcode can be used in case the original passcode is lost or forgotten. The code "0772" will unlock the locked setting.

12.8 Unit Display

From the Settings Menu (Figure A), tap  to enter the selection options, Figure B.

- Tap  to switch between °F or °C.
- Tap  to switch between 12-HR or 24-HR format.
- Tap  to return to the Settings Menu. Tap again to return to the Main Menu.

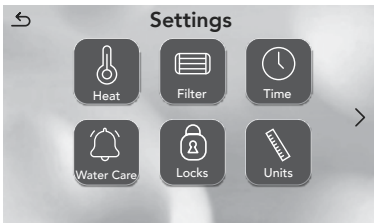

Figure A

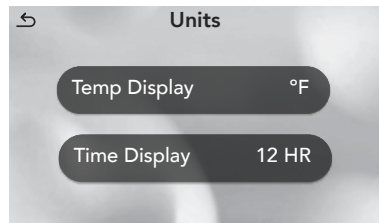



Figure B

12.9 Programming the Language

From the Settings Menu (Figure A), tap  to enter the selection options, Figure B.

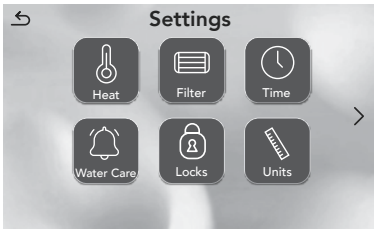

Figure A

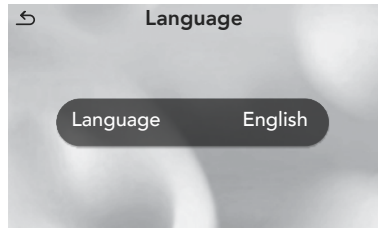



Figure B

1. There are 10 languages to select from: English, French, Spanish, German, Italian, Czech, Swedish, Norwegian, Finnish, and Polish.
2. To select a language, tap  to scroll through and select the language you want to display, Figure C.
3. Tap  to return to the Settings Menu. Tap again to return to the Main Menu.

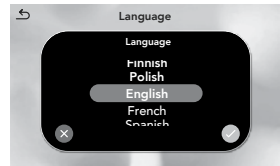



Figure C

12.10 Programming the Panel

From the Settings Menu (Figure A), tap  to enter the selection options, Figure B.

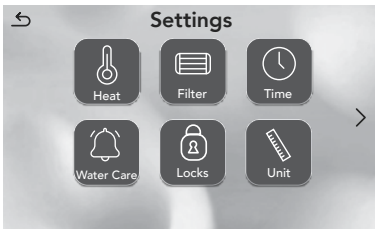

Figure A

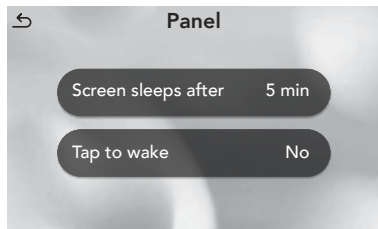



Figure B

Sleep:

1. Tap  to select the Sleep time out, Figure C.
2. Scroll through the column to select the number of minutes before the panel goes to sleep. This feature activates when there is no activity on the panel.
3. Tap  to return to the Settings Menu. Tap again to return to the Main Menu.

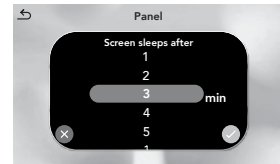

Figure C

Wake:

1. Tap to select the Wake feature, Figure B.
2. If you select No, when the display is asleep, Figure D will briefly appear and then switch to the Main Menu.
3. If you select Yes, when the display is asleep, Figure E will appear. You must tap each of the numbers to go to the Main Menu.



Figure D

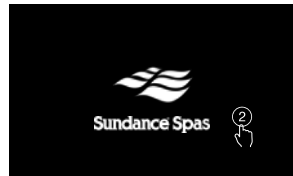
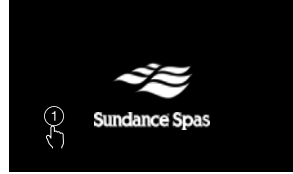



Figure E

12.11 Diagnostic Information

From the Settings Menu (Figure A), tap  to enter the selection options, Figure B.

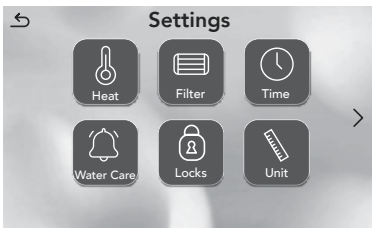

Figure A

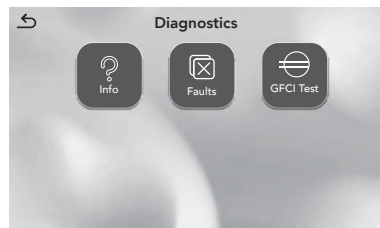

Figure B

Info:

Displays various system information about the hot tub. This information is helpful when servicing the hot tub.

Faults:

Displays any faults detected by the hot tub. It will store up to 8 fault settings.

GFCI Test:

When pressed, it will perform a test for the GFCI breaker.

13.0 Hot Tub Maintenance

Proper and regular maintenance of your hot tub will help it retain its beauty and performance. Your authorized Sundance Spas dealer can supply you with all the information, supplies, and accessory products you will need to accomplish this.



DANGER: RISK OF SEVERE INJURY OR DROWNING BY ENTRAPMENT!

- Keep hair, loose articles of clothing or hanging jewelry away from suction fittings, rotating jets or other moving components to avoid entrapment that could lead to drowning or severe injury.
- Never use the spa unless all suction guards, filter, filter lid, or skimmer assembly are installed to prevent body and/or hair entrapment.
- Never operate or use the spa if the filter, filter lid, or skimmer assembly are broken or any part of the skimmer assembly is missing. Please contact your dealer or nearest service center for service.
- The suction fittings and suction covers in this spa are sized to match the specific water flow created by the pump(s). If it is necessary to replace the suction fittings, suction covers or pump(s), be sure that the flow rates are compatible and are in compliance with the VGB Safety Act, page 2.
- Never replace a suction fitting or suction cover with one rated less than the flow rate marked on the original suction fitting. Using improper suction fittings or suction covers can create a body or hair suction entrapment hazard that may lead to drowning or severe injury.
- Owners must alert all spa users to the potential risk of Hair, Limb, Body, Evisceration (disembowelment), and Mechanical Entrapment, page 6.

13.1 Cleaning/Replacing the Filter Cartridge

A reminder message appears on the control panel display, after a specified number of days, to remind you to clean the MicroClean® Ultra II filters. This reminder must be reset at each interval. Refer to Section 12.6, for additional information and programming details.



Your Sundance hot tub is equipped with a two-stage MicroClean Ultra II filter cartridge assembly under the filter lid (Sections 9.1-9.19 pages 22-40). Debris is filtered by the filter/circulation pump drawing water through the filter assembly 8 hours a day, 7 days a week (unless programmed otherwise). To ensure optimum performance, clean the outer pleated filter and center insert monthly. Then replace the center insert every 6 months, or as needed thereafter.

TO DECREASE RISK OF DEATH, DROWNING, OR ENTRAPMENT, ALWAYS TURN POWER TO THE HOT TUB OFF BEFORE REMOVING THE MICROCLEAN ULTRA II FILTER ASSEMBLY!

Note: Make sure to remove the SmartChlor holder prior to removing the filter.

Filter Cleaning/Replacement Procedure:

1



DANGER: TURN POWER TO SPA OFF! TO DECREASE RISK OF DEATH, DROWNING, OR ENTRAPMENT, NEVER OPERATE SPA WHEN FILTER IS NOT PROPERLY INSTALLED OR IF WEIR ASSEMBLY IS DAMAGED OR ALTERED!



2

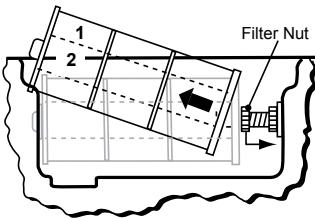

Filter Cleaning Requirements:

- Clean MicroClean Ultra II Pleated Filter (1) monthly and replace every 18 months.
- Rinse off MicroClean Ultra II Insert (2) monthly and replace every 6 months or as needed.

Filter Removal Instructions:

Loosen filter nut to provide clearance, then remove MicroClean Ultra II Filter Assembly from spa.

3

Monthly Filter Cleaning Procedure

We recommend cleaning the outer pleated filter (1) with a high pressure water nozzle and the filter insert (2) with a low-pressure water nozzle monthly. Periodically, the outer pleated filter cartridge (1) will require a more thorough cleaning to remove embedded oils and minerals by using special spa filter cleaners offered by your spa dealer. Always remove the center filter insert (2) before cleaning the outer filter (1) with chemicals. Never use filter cleaners of any kind on the filter insert (2) or it may be damaged, come apart or allow impurities to re-enter the water, increasing the risk of contracting a waterborne illness (e.g. an infection, bacteria or virus) and/or respiratory ailments.

Procedure:

1. Grasp center filter insert end cap (2) in hand and pull outward from pleated cartridge (1). If filter insert (2) is 6 months old, throw it away and purchase new one. DO NOT install new insert at this time.
2. Rinse debris from all outer filter (1) pleats using a garden hose and high-pressure nozzle. Repeat process until all filter pleats are clean. Then rinse debris from inside of filter (1). If chemical cleaners are used, follow manufacturers instructions.

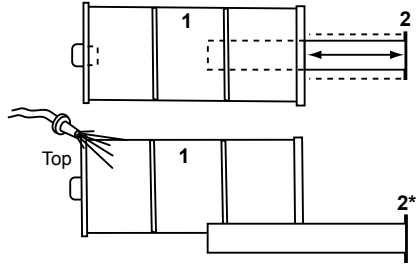

Lightly rise filter insert (2) and place in clean location. *DO

NOT use chemical cleaners or high-pressure nozzle on insert (2) or it may be damaged, come apart or allow impurities to re-enter the water, increasing the risk of contracting a waterborne illness (e.g. an infection bacteria or virus) and/or respiratory ailments.

3. Install filter insert (2) into outer pleated filter (1) by gently sliding inward until a slight resistance is felt approximately 1/4" from bottom. Lightly tap insert end with palm of hand to "snap" in place. Insert is properly installed when end cap rests "flush" against outer filter end cap.
4. Install Filter assembly back into spa by performing step 2 in reverse order. Tighten filter nut so it just touches the filter face. DO NOT OVERTIGHTEN!
5. Turn power to spa back on.

Replacement filter cartridges may be purchased from your Sundance Spas dealer.

13.2 Removing the Cabinet Panels

The skirt panels provide easy access to the equipment bay and components without having to unscrew the panel. To remove the skirt panels, follow the steps below:

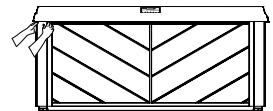

Figure A

1. Grab one of the corner panels, from the top, then gently pull the panel forward to unsnap it from the holding clip then pull up to remove, Figure A. Place the panel in a safe location to prevent from damaging it. Repeat the steps to remove the other corner panel.

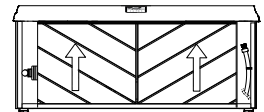

Figure B

2. Grab the bottom of the panel and slightly lift to release it from the top mount. Tilt the panel and pull down to remove, Figure B. Before completely removing the panel, take hold of the indicator light wire and gently pull on it to slide the light from the housing. Place the panel in a safe location to prevent from damaging it.

3. If equipped, fold the Vapor barrier out of the way, and remove any EPS insulation boards.
 4. To reinstall the panel just follow the steps above in reverse order.
- Note:** Exposure of the cabinet to heat could cause the cabinet to warp. Should the cabinet warp, once it is installed, the warping is not visible. However, it does make the removal and replacement a little more challenging.

13.3 Draining And Refilling

Every 3 months, you will need to replace the hot tub's water. The frequency depends on a number of variables including the amount of use, attention paid to water quality maintenance, etc. You will know it is time for a change when you cannot control sudsing and/or you can no longer get the normal feel or sparkle to the water even though the key water balance measurements are all within the proper parameters.



CAUTION! READ THIS BEFORE DRAINING: To decrease damage to the hot tub's components, turn off power to the hot tub at the circuit breaker before draining it. Do not turn the power back on until your hot tub has been refilled. There are certain precautions to keep in mind when draining your hot tub. If it is extremely cold, and the hot tub is outdoors, freezing could occur in the lines or the equipment (see "Winterizing," page 73). On the other hand, if it is hot outdoors, do not leave the hot tub's surface exposed to direct sunlight for long periods.

A. Draining Procedures:

1. Turn off power to hot tub at breaker.
2. Locate drain hose line attached to one of the front corners, Figure A. Hold drain hose above water line. Unscrew drain valve cap to expose the underlying male garden hose fitting, Figure B.
3. Attach female garden hose end to drain fitting and route opposite end of garden hose away from hot tub.
4. After spa has completely drained, reinstall drain cap on drain valve finger tight! **DO NOT OVERTIGHTEN!**
5. Place drain hose back inside the spa equipment bay.

Note: Refer to "Hot Tub Fill Up Procedure" (page 16) for recommended filling instructions.



Figure A

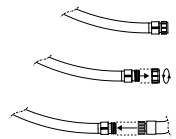

Figure B

13.4 Cleaning The Hot Tub Interior

To preserve the sheen of your hot tub's surface, it is crucial that you avoid using abrasive cleaners or cleaners which have adverse chemical effect on the surface. If you are not certain as to the suitability of a particular cleanser, consult your authorized Sundance Spas dealer. Regardless of the cleanser used, use extreme care to assure that no soap residue is left on the surface. This could cause severe sudsing when the hot tub is refilled.

13.5 Pillow Care

Remove and clean the headrest pillows as needed with soapy water using a cloth or soft-bristle brush. Always remove the pillows when adding chemical shock treatment to the spa water. The pillows can be returned to the spa when the sanitizer reading is stable as recommended on the inside cover of the manual.

Note: Actual pillow could vary from image shown.

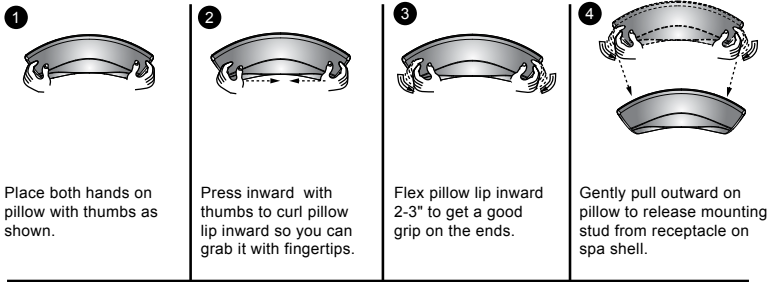
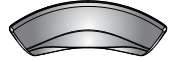

5 Wash pillow(s) in a mild detergent soap and warm water solution. Never machine wash your pillows or attempt to clean them with a cleaning agent!

6 To reinstall pillows: Simply align pillow over mounting stud receptacle, then gently push inward to snap in place.

13.6 Maintaining the Hot Tub Cabinet

The hot tub cabinet require little or no maintenance of any kind. To clean, wipe cabinet with a clean towel and mild detergent soap solution.



CAUTION: Never spray cabinet with a high pressure garden hose for any reason since this action may induce an electrical short in the hot tub's electrical equipment.

13.7 Cover Care And Maintenance

Hot tub covers distributed by Sundance Spas, Inc., have a SUNSTRONG™/SUNSTRONG™ Extreme encasement. The SUNSTRONG/SUNSTRONG Extreme encasement also referred to as the cover "skin" is attractive and durable. Regular monthly cleaning is strongly recommended and may increase the longevity of your cover.

Note: It is highly recommended that you DO NOT put the seam over the control panel. This will cause premature failure of the control system.

A. To clean and condition the encasement (cover skin):

1. Use a garden hose to remove any debris.
2. Using a large sponge or soft bristle brush, use diluted or mild soap to gently scrub the top.
3. Rinse and clean and do not allow soap to dry on the cover. Do not use soap on the underside of the cover.
4. Do not use any solvents, abrasive cleaners or strong detergents. Do not use products that contain silicone or alcohol.

B. Additional Care and Maintenance Instructions:

1. Debris can accumulate on the spa cover. Removal of snow or other debris will help to avoid breakage of the foam cores.
2. Be sure to lock the cover straps to secure the cover from unwanted or accidental entry.
3. Do not place heavy objects on the cover.
4. Do not walk, sit or stand on the cover.
5. Do not drag or use the flaps/skirt or the cover lock straps to remove the cover.
6. Use only recommended cover lift systems.
7. Use only chemicals and cleaners recommended by Sundance Spas.
8. Remember to keep spa covered when not in use. Maintaining proper water levels assures efficient operation and efficient electrical usage.
9. Do not expose your spa to the sun for extended periods of time as UV rays can damage the interior surface.
10. Use caution when removing cover. Before removing cover, assure all locks have been released to avoid lock breakage and/or cover strap damage.

13.8 Winterizing

Your Sundance hot tub is designed to automatically protect itself against freezing when operating properly. During periods of severe freezing temperatures, you should check periodically to be certain that the electrical supply to the hot tub has not been interrupted. In extreme bitter cold weather, less than 32°F (0°C), program the circulation pump to run for 24 hours to prevent freezing.

If you do not intend to use your hot tub, or if there is a prolonged power outage during periods of severe freezing temperatures, **it is important that all water be removed from the hot tub and equipment to protect against damage from freezing.**

Expert winterization of your spa is highly recommended, contact your authorized Sundance Spas dealer. In emergency situations, damage can be minimized by taking the following steps:

CAUTION: TURN OFF POWER TO HOT TUB!

1. Follow the directions (Section 13.3) for draining the hot tub.
2. Turn the massage/diverter selector(s) to the middle combo position to allow the water in the plumbing lines to drain, page 51.

3. Turn the waterfall valve(s) to the open position to allow the water in the plumbing lines to drain, page 52.
4. As the water level drops below the seats, use whatever means necessary to get the water out of the recessed seating areas and into the footwell, such as a wet/dry vacuum.
5. Open all the air controls and leave them open until you resume use of the spa, page 52.
6. When the water level ceases to drop, use whatever means available to remove any remaining water from the footwell, such as a wet/dry vacuum.
7. Remove the equipment-side cabinet panels and locate the drain plugs in the front of each pump (Figures A and B, page 14). Remove these plugs to allow the water to drain out of the pumps.

Note: Approximately 1 to 2 gallons will be released during this procedure. Use a wet/dry vacuum or other means to keep this from flooding the equipment compartment. Replace the drain plugs.

8. Loosen hose clamp at bottom of CLEARRAY® system and pull hose off of CLEARRAY fitting (twist the hose back and forth while pulling downward). Tip hose down and allow to drain, then reinstall hose and clamp. Remove the cover of the CLEARRAY system to access the UV bulb and quartz tube. Remove and store the UV bulb in a safe location. Remove and dry off the quartz tube then reinstall it. Depending on the length of time, consider replacing the UV bulb when you resume use of your hot tub.
9. Re-install cabinet side panels and cover hot tub so that no moisture can enter into it. Consult your Sundance Spas dealer if you have any questions regarding winter use or winterizing.

13.9 Restarting Your Hot Tub in Cold Weather

If you want to start up your hot tub after it has sat empty for a time in freezing temperatures, be aware that the water remaining in certain sections of the piping may still be frozen. This situation will block water flow preventing the hot tub from operating properly and possibly damaging the equipment. We recommend you consult your dealer for guidance before attempting to restart your hot tub under these conditions.

14.0 Water Quality Maintenance

To decrease the risk of contracting a waterborne illness (e.g. an infection, bacteria or virus) and/or respiratory ailments, maintain water quality within specified limits. This will enhance your enjoyment and prolong the life of the hot tub's equipment. Doing so requires regular attention because the water chemistry involved is a balance of several factors. Procrastination in regard to water maintenance will result in poor and potentially unhealthy conditions for soaking and even damage to your hot tub investment. For specific guidance on maintaining water quality, consult your Authorized Sundance Spas dealer who can recommend appropriate chemical products for sanitizing and maintaining your hot tub.



WARNING: FAILURE TO MAINTAIN WATER QUALITY WILL:

- Increase risk of contracting a waterborne illness (e.g. an infection bacteria or virus) and/or respiratory ailments.
- Damage the equipment, components and spa shell, which are not covered under the hot tub's warranty.

CAUTION: Never store hot tub chemicals inside the hot tub's equipment bay. The equipment bay may reach elevated temperatures, this is where high voltage electronic devices are located. This area is not intended for storage of any kind.

14.1 pH Control

pH is a measure of relative acidity or alkalinity of water and is measured on a scale of 0 to 14. The midpoint of 7 is said to be neutral, above which is alkaline and below which is acidic. In hot tub water, it is very important to maintain a slightly alkaline condition of 7.4 to 7.6 pH. Problems become proportionately severe the further outside of this range the water gets. A low pH will be corrosive to metals in the hot tub equipment. A high pH will cause minerals to deposit on the interior surface (scaling). In addition, the ability of the sanitation agents to keep the hot tub clean is severely affected as the pH moves beyond the ideal range. That is why almost all hot tub water test kits contain a measure for pH as well as sanitizer.

14.2 Sanitizing

To destroy bacteria and organic compounds in the hot tub water, a sanitizer must be used regularly. Your Sundance hot tub is equipped with the Brominator™, a special compartment built into the floating skimmer gate to hold the SunPurity™ mineral cartridge designed specifically for your hot tub or bromine tablets. By regulating the number of bromine tablets in the Brominator you can control the amount of bromine, which is actively working, in your hot tub water. A bromine residual of no less than 2.0 ppm is generally considered desirable. A two-part bromine system or granular chlorine (dichlor) are also acceptable sanitizers. When adding spa shock (chlorine or non-chlorine) or pH balancing chemicals, activate the jets pump(s) and leave the spa cover open for a minimum of 20 min-

utes. By doing this you will allow excess chemical vapors to exit the spa, protecting pillows and plastic knobs from chemical attack.



WARNING: RISK OF PERSONAL INJURY, DROWNING OR ENTRAPMENT!

Never leave your hot tub unattended for any reason while the cover is open and accessible, especially to small children and animals!

CAUTION: RISK OF PERSONAL INJURY OR SPA DAMAGE!

Never add chlorine tablets (trichlor) or acid to your hot tub for any reason! These chemical may damage components within your hot tub, burn or irritate your skin, create a rash, and void the manufacturer warranty for your spa.

14.3 CLEARRAY Active Oxygen™ System

Your new hot tub has the CLEARRAY Active Oxygen™ System installed. The CLEARRAY Active Oxygen™ System is an exclusive technology utilizing ultraviolet light and ozone technology to help keep your water clean*. The ballast is the power supply for the CLEARRAY Active Oxygen™ System; it has two LED indicator lights, the green indicating incoming power flow and the red indicating the system is properly working. CLEARRAY Active Oxygen™ is standard for all models.

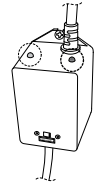
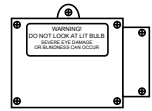

After a year the bulb must be replaced. A message will appear on the LCD display when the time allotted has expired. In order to clear the message, a new UV bulb needs to be installed and the timer must be reset (Sec. 12.6, page 61).



WARNINGS:

- Do not operate the UV-C emitter when it is removed from the appliance enclosure.
- This appliance contains a UV-C emitter.
- Unintended use of the appliance or damage to the housing may result in the escape of dangerous UV-C radiation. UV-C radiation may, even in little doses, cause harm to the eyes and skin.
- Appliances that are obviously damaged must not be operated.
- Read the maintenance instructions before opening the appliance.

*Clean is defined as the removal of microscopic (to 30 µm level) debris from the water. Ozone aids in the grouping of small debris. Once combined, the debris can be more easily caught by the filtration process.

14.4 CLEARRAY® Bulb Replacement and Quartz Tube Maintenance

Important: It is **MANDATORY** that the UV bulb is replaced and the quartz tube be cleaned every 12 months to maintain optimum performance.

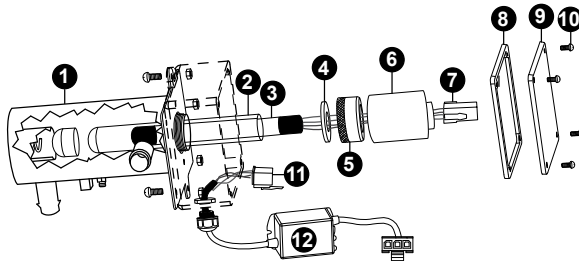

FIGURE 1



DANGER: TURN THE SPA BREAKER TO THE OFF POSITION!



DANGER: DRAIN THE SPA IF YOU ARE REPLACING OR CLEANING THE QUARTZ TUBE!



WARNING: ALLOW LAMP TO COOL DOWN PRIOR TO REMOVING FROM QUARTZ TUBE.



DANGER: NEVER LOOK AT THE LIT BULB. THIS CAN CAUSE SEVERE EYE DAMAGE OR BLINDNESS.

UV bulb replacement and quartz tube maintenance:

Note: Location of the CLEARRAY and connection may vary by model.

1. Turn the breaker to the spa OFF. DRAIN YOUR SPA.

Note: If you are only replacing the UV bulb then the spa does not have to be drained. You will need to drain it if you are replacing or cleaning the quartz tube.

2. Once the UV bulb has cooled off remove the CLEARRAY System enclosure cover (9) and gasket (8) by removing the four screws (10). This will expose the UV bulb and connections, Figure 2.

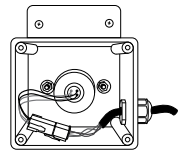

FIGURE 2



DANGER: NEVER REMOVE COVER WITHOUT FIRST TURNING OFF AT POWER SOURCE AND DRAINING THE SPA.

FIGURE 3

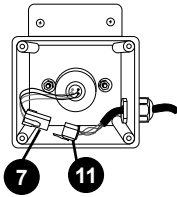

FIGURE 4

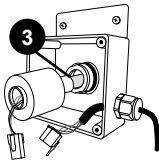

FIGURE 5

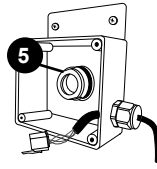
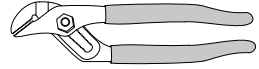

FIGURE 6



3. Disconnect UV bulb socket (7) from the power cord socket (11), Figure 3.
4. Slowly remove the UV bulb (3) out of the quartz tube, Figure 4.
5. Remove the quartz seal compression nut (5) by turning it **counterclockwise**, Figure 5. Use a pair of channel-lock pliers if needed, Figure 6. You will notice that there is a stainless steel compression washer (4) which slides over the quartz tube, save the washer (4) for later use, Figure 7.
6. Now you are ready to clean or replace the quartz tube (2). For cleaning the quartz tube (2), follow steps 7 and 8 then proceed from step 9. For replacing quartz tube (2), skip steps 7 and 8 and proceed from step 9.
7. **Cleaning quartz tube:** Clean the quartz tube by wiping, until clear, using a paper towel or a dry cotton cloth. If needed, a household tub and shower lime removal product can be used.

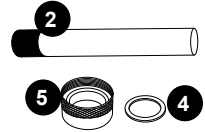

FIGURE 7



WARNING: Do not use abrasive cleaners as they can scratch the quartz tube surface.

8. Rinse the quartz tube with clean water to completely remove any cleaning products that were used in step 7.
9. **Replacing quartz tube:** You will notice that the new quartz tube does not have a black cushion on the domed end as the old quartz tube does. This is normal as the cushion was provided with the original quartz tube to protect it from breakage during transportation. Place the new quartz tube (2) into the water chamber (1) with the domed end first making sure it is inserted and seated inside the quartz end holder. Only a small portion will be exposed when it is seated correctly.
10. Reinstall the compression washer (4) over the open end of the quartz tube (2).
11. Reinstall and hand tighten the quartz seal compression nut (5) by turning it **clockwise**.
12. Refill your spa.
13. **System Test 1:** Assure there is no water dripping from the seal compression nut (5). If water is visible, STOP and tighten the compression nut (5) using a pair of channel lock pliers to a maximum of 1/4 turn. If that does not fix the leak, then repeat quartz tube maintenance process from step 1 through step 12. Make sure there is no water leaking before proceeding to step 14.

14. **System Test 2:** Reconnect the CLEARRAY unit to the controller. Turn breaker back ON. Turn on the pump to circulate the water through the CLEARRAY. Wait for 5 minutes and assure no water is dripping. If water is visible, STOP, fix the leak by repeating quartz tube maintenance process from step 1 through step 13. **Make sure there is no water visible. Turn the pump and breaker OFF BEFORE proceeding to step 15.**
15. Reconnect the UV bulb socket (7) to the power cord socket (11) make sure you use the latex glove provided when handling the UV bulb.



WARNING: DO NOT TOUCH THE NEW UV BULB WITH YOUR BARE HAND. Oil on your skin will cause hot spot on the UV bulb and shorten the life of your UV bulb. Use the provided latex glove to handle the UV bulb.

16. Slide the new UV bulb (3) back inside the quartz tube.
17. Reinstall the black bulb boot (6) back over the quartz seal compression nut (5).
18. Reinstall the enclosure cover (9) with gasket (8) and secure with the screws.
19. Properly dispose of the old UV bulb.



WARNING: This CLEARRAY System includes a UV bulb, which contains mercury. Dispose of the bulb in accordance with disposal laws. See www.lamprecycle.org.

20. Once power is activated you can check the ballast (12), Figure 8, to see if the CLEARRAY is functioning; it has two LED indicator lights the green indicating incoming power flow and the red indicating the system is properly working.

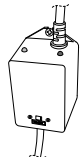

FIGURE 8

14.5 Other Additives

Many other additives are available for your hot tub. Some are necessary to compensate for out-of-balance water, some aid in cosmetic water treatment and others simply alter the feel or smell of the water. Your Authorized Sundance Spas dealer can advise you on the use of these additives.

14.6 Stainless Steel Handrail Maintenance (if equipped)

The handrails in your Sundance hot tub are manufactured from a high quality 316 stainless steel alloy. Many people are familiar with the term “stainless steel” and are surprised to learn that it does indeed rust and corrode in the presence of chloride salts, free chlorine, or sulfide gasses. The bad news is the environments that produce these elements are ocean spray, salted highways, chemical treatments added to swimming pools and hot tubs, and ground water in numerous coastal areas. The good news is with proper care, your hot tub’s handrails can maintain their original finish.

If your stainless handrails shows signs of rusting you should:

- Wash with fresh water (a good detergent won't hurt).
- Clean with a good car chrome polish.
- Wax with an automotive or fiberglass wax.

You should never:

- Clean with chlorinated cleaners or scouring powders.
- Use sand paper, "Scotch Brite," Brillo pads, or similar abrasive products.
- Clean with muriatic or hydrochloric acids. Vinegar is ok, but it won't do much to remove rust.

15.0 Troubleshooting - Display Messages

Following is a listing of all the possible messages along with their meanings. **Always insist on genuine Sundance replacement parts.**

1. Freeze (Code 1): Possible freeze condition.
2. Sensor Balance Transient (Code 15): Sensors are out of sync.
3. Heat Low Flow (Code 15): The water flow is low.
4. Failed Flow (Code 17): The water flow has failed.
5. RTC Failure (Code 20): The clock has failed.
6. Persistent Memory Fail (Code 21): The settings have been reset.
7. Checksum Failure (Code 22): Program memory failure.
8. Config Error (Code 23): Configuration error. Contact your authorized dealer or service organization.
9. Sensor Balance Latch (Code 26): Sensor are out of sync. Contact your authorized dealer or service organization.
10. Heater Dry (Code 27): The heater is dry.
11. Heater Maybe Dry (Code 28): The heater maybe dry.
12. Spa Overheat (Code 29): **DO NOT ENTER THE WATER!** Spa water temperature above acceptable limits. Spa water is too hot.



**WARNING: RISK OF HYPERTHERMIA (OVER-HEATING)
CAUSING SEVERE INJURY, BURNS, OR WELTS.**

13. Heater Overheat (Code 30): **DO NOT ENTER THE WATER!** The heater is too hot.



**WARNING: RISK OF HYPERTHERMIA (OVER-HEATING)
CAUSING SEVERE INJURY, BURNS, OR WELTS.**

14. Sensor Fault A (Code 31): Sensor A fault. Contact your dealer or service organization.
15. Sensor Fault B (Code 32): Sensor B fault. Contact your dealer or service organization.
16. Stuck (Code 34): A pump may be stuck.
17. Hot (Code 35): Hot fault. Contact your authorized dealer or service organization.
18. GFCI Failure (Code 36): The GFCI test failed.
19. Rest Mode Temp (Code 38): Run Jets 1 to get temperature.
20. Beta Version (Code 39): Test software is installed.
21. Set Time (Code 40): Set the time.
22. J29 Shorted (Code 44): J29.
23. Heatpump Comm Lost (Code 68): The Clim8zone has stopped communicating.
24. Heatpump Fault (Code 69): The Clim8zone reported an internal fault.
25. Heatpump Defrosting (Code 70): The Clim8zone is defrosting.
26. Heatpump Stuck On (Code 71): The Clim8zone did not turn off.
27. Heatpump Stuck Off (Code 72): The Clim8zone did not turn on.
28. Heatpump Flow Fault (Code 73): The Clim8zone reported a flow fault.
29. Heatpump Unexpected Shutoff (Code 74): The Clim8zone turned off.
30. Heater Authentication Error (Code 80): The heater authentication has failed. Could be caused by a bad chip on the heater or expander board.

31. **CLEARRAY Replacement Reminder:** This message will appear when the CLEARRAY bulb reminder time has expired (Figure A). The CLEARRAY bulb must be replaced.



Figure A

32. **MicroClean Outer Filter Reminder:** This message will appear when the filter reminder time has expired (Figure B). Remove the MicroClean Outer filters for cleaning or replacement.



Figure B

33. **MicroClean Inner Filter Reminder:** This message will appear when the filter reminder time has expired (Figure C). The MicroClean Inner filter must be replaced.



Figure C

34. **Water Refresh Reminder:** This message will appear when the "Water Refresh" timer has expired (Figure D). The water needs to be drained and refilled with fresh water.



Figure D

35. **Extended Temperature Activated:** The spa is set to go up to 104°F (40°C), but it can be set to reach 106°F (41°C). To access the extended temperature, you need to set the temperature to 104°F (40°C). The press and hold your finger over the temperature reading for about 3 seconds. The temperature reading will turn white, and the indicator bar will turn red and start flashing, Figure E. This indicates the system is ready. Tap (+) to raise the temperature up to 105°F (40.5°C), press again to reach 106°F (41°C).

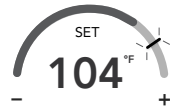

Figure E

Note: The heat indicator bar will be red and blinking to indicate that the feature is active.



WARNING: RISK OF HYPERTHERMIA (OVER-HEATING) CAUSING SEVERE INJURY, BURNS, WELTS OR DEATH!

Water temperature in excess of 104°F (40°C) may be injurious to your health.

16.0 Troubleshooting - Procedures

In the unlikely event your hot tub is not working the way you believe it should, please first review all the installation and operating instructions in this manual and check the message on the panel display; second, if you are still not satisfied it is working properly, please follow the appropriate troubleshooting instructions.

PROBLEM	PROCEDURE
None of the components operate (i.e. pump, blower, light)	Check the control panel lights. <ol style="list-style-type: none"> 1. If there are letters or symbols displayed on the screen, refer to the previous section to determine meaning and action required. 2. If nothing appears on the screen: <ol style="list-style-type: none"> A. Check the household circuit breaker. B. Contact your Sundance Spas dealer or qualified service technician.
Pump does not operate and icon does	Depress JETS Button. <ol style="list-style-type: none"> 1. If no sound is detected or if a buzzing sound is detected, turn off power to the spa and contact your authorized dealer or qualified service technician. 2. If motor operates, but now water flows to jets: <ol style="list-style-type: none"> A. Pump may not be properly primed. See instructions below. B. Contact your Sundance Spas dealer or qualified service technician.
Filter/circulation pump off	<ol style="list-style-type: none"> 1. Verify filter/circulation pump is programmed to run (page 57). 2. Hot tub water is warmer than 95°F (35°C) and 2°F (1°C) warmer than the set temperature. The “Summer Logic” safety feature has activated.

CAUTION: If freezing conditions exist and pump is not operational, take measures to protect the system from freeze damage. See Section titled “Winterizing,” page 73.

PROBLEM

PROCEDURE

Poor jet action
(Sections 9.1-9.19, pages 22-40)

1. Make certain the jets pump is turned on.
2. Check position of massage selectors.
3. Open air control for selected jet system.
4. Check for adequate water level.
5. Check for dirty filter (pages 68-70).

Water is too hot

1. Reduce thermostat setting (page 18).
2. Switch hot tub to Economy mode to turn heater on only during programmed filter cycles (page 56).

No heat

1. Check thermostat setting.
2. Keep the cover in place while heating.
3. If “heater on” indicator is lit but no temperature rise is experienced after a reasonable period of time, contact your Sundance Spas dealer or qualified service technician.

Should checking the above steps fail to correct the problem, please call your authorized dealer so that he may arrange service.

Sundance builds the best hot tubs in the industry. Nonetheless, we are always striving to improve the quality and features of our products. Your input as a Sundance hot tub owner is a cherished part of this process. If you have any comments or suggestions, or if you wish to be informed on any new products for your hot tub, please write to us.

CONGRATULATIONS on your good taste and welcome to the happiest and most relaxed family in the world!

17.0 Typical Hot Tub Wiring Diagrams A-B (North American 60 Hz Models Only)

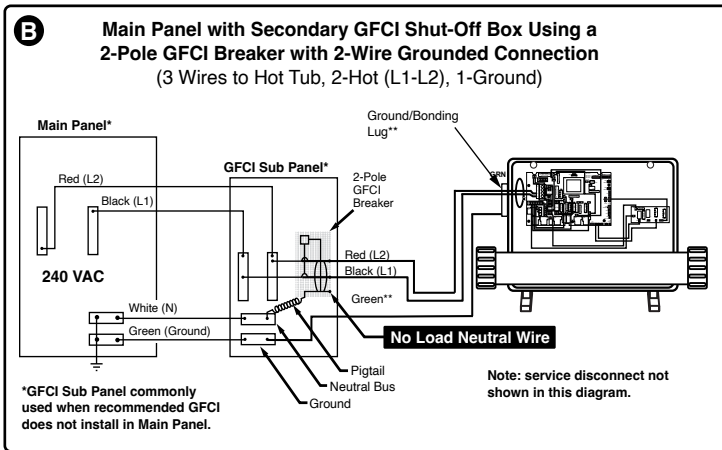
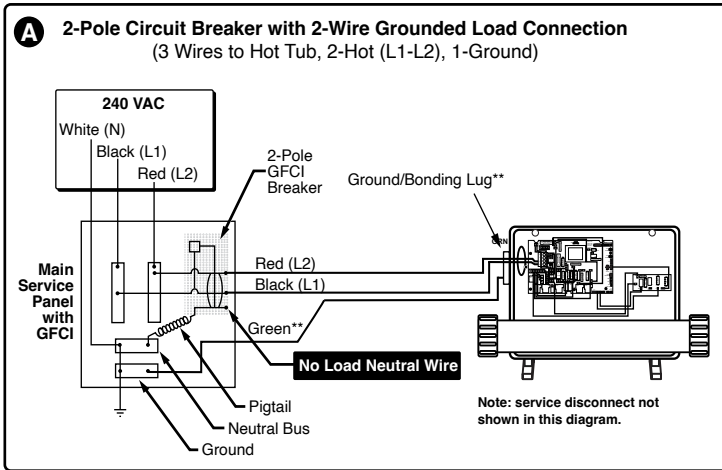

⚠ DANGER
RISK OF SHOCK OR
ELECTROCUTION!



Turn power off before servicing. This task should only be performed by a qualified technician.

18.0 North American 60 Hz Electrical Wiring Diagram

18.1 North American 60 Hz Models Electrical Wiring Diagram

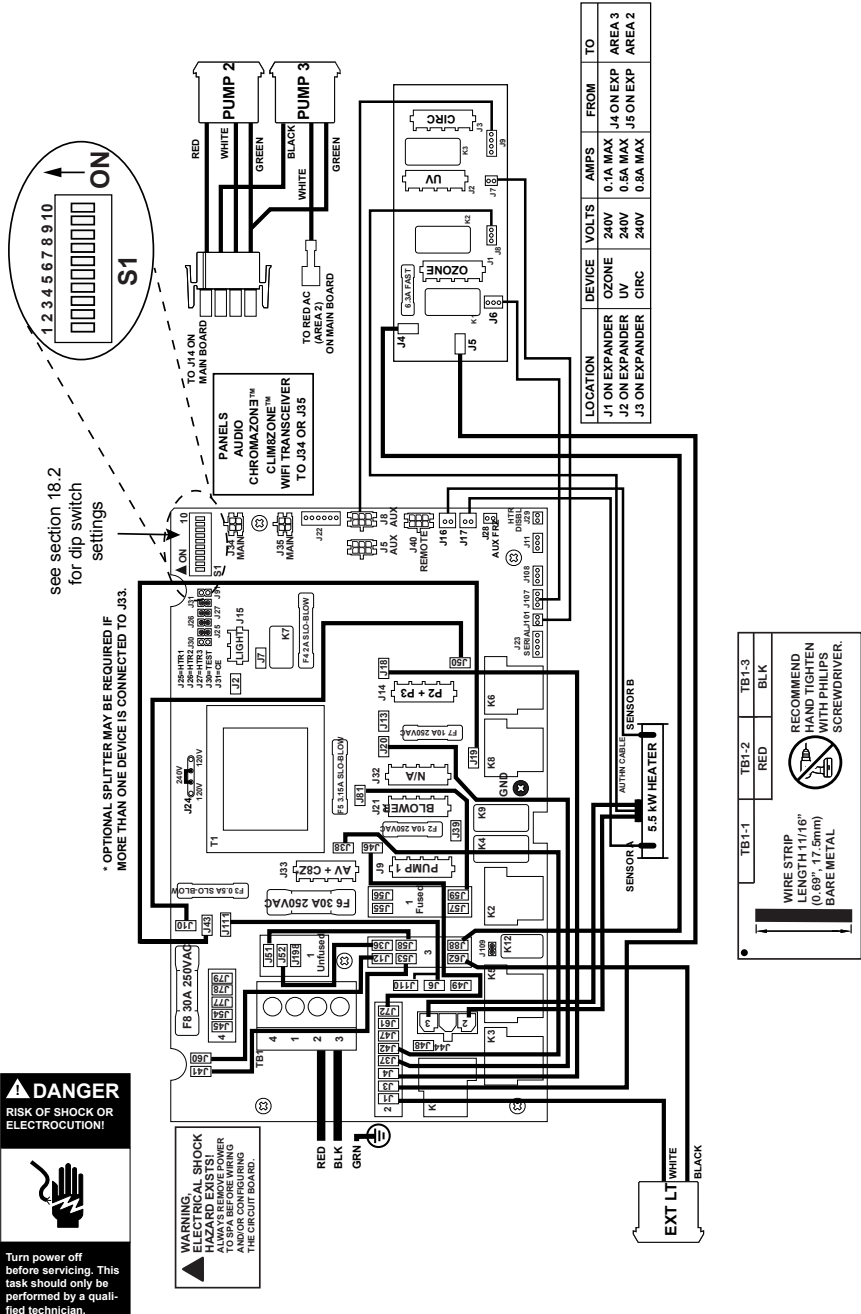

18.2 Dip Switch Settings

The dip switches are at the S1 location on the board.

A. Switch settings for Domestic 60Hz Models

OFF Position	S1 SWITCH	ON Position
TEST MODE OFF	◀ 1	TEST MODE ON
MUST BE OFF	◀ 2	N/A
SEE TABLE	◀ 3	SEE TABLE
SEE TABLE	4 ▶	SEE TABLE
MUST BE OFF	◀ 5	N/A
STORE SETTINGS**	◀ 6	MEMORY RESET**
MUST BE OFF	◀ 7	N/A
NOT ASSIGNED	◀ 8	NOT ASSIGNED
NOT ASSIGNED	◀ 9	NOT ASSIGNED
DEMO MODE OFF	◀ 10	DEMO MODE ON

**Switch #6 should be set to OFF upon final installation. All unused switches should be OFF.

BREAKER	DIP SWITCH NUMBER									
	1	2	3	4	5	6	7	8	9	10
40A	OFF	OFF	ON	OFF	OFF	OFF	OFF	OFF	OFF	OFF
50A*	OFF	OFF	OFF	ON	OFF	OFF	OFF	OFF	OFF	OFF
60A	OFF	OFF	ON	ON	OFF	OFF	OFF	OFF	OFF	OFF

*50A is the factory default setting

Location	Device	Volts	Max Amps	From	To
J9	1-SP Pump 1	240V	11A Max	J46	Area 2
J14	1-SP Pump 2 + 1-SP Pump 3	240V	11A Max + 11A Max	J18	Area 2
	J14 Line 1 Connection			J43 J10	J19 J50
J15	Spa Light	10V	2A*		
J21 J32	Blower N/A	240V	4A Max	J20	Area 2
	Blower Line 1 connection			J81	J59
J33	AV + Clim8zone (C8Z)	240V	2A + 8A	J38	Area 2
J44	Heater	240V	5.5 kW		

* 2A limit is shared by J15 Spa Light and Chromazone

