

A black, square Jacuzzi hot tub is the central focus, situated on a rooftop deck. The tub is illuminated from within, showing bubbling water. To the left, there are wooden steps leading up to the tub. To the right, a small, round, metallic table holds a stack of white towels. The background features a dense city skyline at dusk, with various skyscrapers and buildings lit up. A large tree is visible on the left side of the deck. The Jacuzzi logo is in the top right corner.

Jacuzzi

J-LX[®] Collection

Owner's Manual: Export

[6530-533EM Rev A](#)

J-LX[®]

J-LXL[®]

Attention New Spa Owner!

Congratulations on the purchase of your new Jacuzzi® spa! The following is a list of automated functions performed by your spa. These functions are listed below in an attempt to alleviate any operational concerns you may have during the first 24 hours of ownership! Also listed below are important maintenance recommendations you should observe on a regular basis to protect your new investment.

Maintain Healthy Spa Water

Always maintain your spa's water chemistry within the following parameters:

	With ClearRay®	Without ClearRay®
pH	7.4-7.6	7.4-7.6
Free Chlorine	no less than 1.0 ppm	3.0-4.0 ppm
Free Bromine	no less than 2.0 ppm	2.0-4.0 ppm
Total Alkalinity	100-150 ppm	100-150 ppm
Calcium Hardness	150-250 ppm	150-250 ppm

IMPORTANT: ClearRay Active Oxygen® system is factory installed. If the ClearRay Active Oxygen® system is altered or is not operating efficiently then follow the “without ClearRay®” water chemistry parameters as defined by the Pool & Hot Tub Alliance. ClearRay® Unit requires an annual bulb replacement to operate properly.



TO DECREASE RISK OF INFECTION OR DISEASE! Always maintain your spas filter as outlined below to ensure healthy spa water. Refer page 49 “Water Quality Maintenance” for additional information.

Required Filter Maintenance

Your new spa is equipped with an advanced water filtration system that provides unsurpassed water quality! To ensure maximum water quality at all times, you should clean both filter cartridges every month, or earlier as necessary. See page 41 for detailed filter cartridge cleaning/replacement instructions.

Required Water Replacement



TO DECREASE RISK OF INFECTION OR DISEASE! You should replace the spa's water every 3 months. The frequency depends on a number of variables including frequency of use, number of users, and attention paid to water quality maintenance. You will know it is time for a change when you cannot control sudsing and/or you can no longer get the normal feel or sparkle to the water, even though the key water balance measurements are all within the proper parameters. See page 49 for additional information.

Specifications and operations subject to change without notice.

Table of Contents

1.0	Important Spa Owner Information.....	1
2.0	FCC Notice	1
3.0	Important Safety Instructions for all Spa Owners	2
3.1	Entrapment Risk	6
3.2	Hyperthermia	7
3.3	PRECAUTIONS-Important Chemical Safety	8
3.4	PRECAUTIONS FOR USE OF PRODUCTS CONTAINING SODIUM BROMIDE	8
3.5	Important Additional Safety Instructions	8
3.6	General Electrical Safety Instructions	8
4.0	Choosing A Location.....	9
4.1	Outdoor Location	10
4.2	Indoor Location	10
5.0	General Electrical Safety Instructions.....	11
6.0	Electrical Wiring Instructions.....	12
7.0	Power Requirements.....	16
8.0	Spa Fill Up Procedure	17
9.0	Spa Features	22
9.1	General Spa Features And Controls.....	22
10.0	Registration and Start-up.....	23
10.1	Start-up Sequence	23
10.2	Register Your New Spa.....	23
10.3	ProTouch™ Control Panel	24
11.0	Operating Instructions	25
11.1	ProTouch™ Control Panel	25
11.2	Activating the Jets Pumps.....	25
11.3	Lights Menu	26
11.4	ClearRay on Demand	27
11.5	Ozone Operation.....	27
11.6	Adjusting Jet Flow.....	27
11.7	Adjusting PowerPro™ MX Jets.....	27
11.8	Adjusting RX Jets.....	28
11.9	Waterfall Control	28
11.10	Air Controls	28
11.11	Selecting the Desired Massage Action	28
11.12	IR and Red Light Therapy.....	28
11.13	Exterior Lights.....	29
11.14	Optional SmartTub® System	29

J-LX Export

12.0	Programming and Operation Instructions	30
12.1	Programming the Heating Mode	31
12.2	Programming the Primary Filter	32
12.3	Programming the Secondary Filter	33
12.4	Cleanup Cycle	34
12.5	Blow-Out Cycle	34
12.6	Water Care Programming	34
12.7	Optional Wi-Fi Setup (not applicable if the optional SmartTub® system is installed)	37
12.8	Locking the Spa	37
12.9	Programming the Time and Date	39
12.10	Programming the Language	40
12.11	Units Display	40
12.12	System Information	40
13.0	Spa Maintenance	41
13.1	Cleaning The Filters	41
13.2	Draining and Refilling	45
13.3	Pillow Care	46
13.4	Cleaning The Spa Interior	46
13.5	Maintaining the Cover	46
13.6	Maintaining The Synthetic Cabinet	47
13.7	Top Rail Care And Maintenance	47
13.8	Stainless Steel Corners	47
13.9	Winterizing	48
13.10	Restarting Your Spa in Cold Weather	49
14.0	Water Quality Maintenance.....	49
14.1	pH Control	50
14.2	Sanitizing	50
14.3	ClearRay Water Purification System	51
14.4	ClearRay® UV Bulb Replacement and Quartz Tube Maintenance	52
15.0	Error/Display Messages	55
16.0	Troubleshooting Procedures.....	59
17.0	Circuit Board Diagrams.....	61
17.1	Export Models (50 Hz)	61
17.2	Dip Switch Settings	62
17.3	Single Service 50Hz Connection	64
17.4	Dual Service 50Hz Connection	64
17.5	Three Service 50Hz Connection	65

1.0 Important Spa Owner Information

Your Jacuzzi spa is constructed to the highest standards and is capable of providing many years of trouble-free use. However, because heat retentive materials are utilized to insulate the spa for efficient operation, an uncovered spa surface and wall fittings directly exposed to sunlight and high temperatures for an extended period are subject to permanent damage. Damage caused by exposing the spa to this abuse is not covered under warranty. We recommend that you always keep the spa full of water when it is exposed to direct sunlight and that you keep the Jacuzzi premium insulating cover in place at all times when the spa is not in use. Read and carefully follow the requirements for your spa's support base found in Section 4.0 titled, "Choosing A Location" (page 9).

Jacuzzi® Hot Tubs constantly strives to offer the finest spas available, therefore modifications and enhancements may be made which affect the specifications, illustrations and/or instructions contained herein.

2.0 FCC Notice

This equipment has been tested and found to comply with the limits for a Class B Digital Device, pursuant to Part 15 of the FCC Rules. These limits are designed to provide reasonable protection against harmful interference in a residential installation. This equipment generates, uses and can radiate radio frequency energy and, if not installed and used in accordance with the instructions, may cause harmful interference to radio communications. However, there is no guarantee that interference will not occur in a particular installation. If this equipment does cause harmful interference to radio or television reception, which can be determined by turning the equipment off and on, the user is encouraged to try to correct the interference by one or more of the following measures:

1. Rearrange or relocate the receiving antenna.
2. Increase the separation between the equipment and receiver.
3. Connect the equipment into an outlet on a circuit different from the circuit connected.
4. Consult the dealer or an experienced radio/TV technician for help. Changes or modifications not expressly approved by the party responsible for FCC compliance could void the user's authority to operate this equipment.

J-LX Export

3.0 Important Safety Instructions for all Spa Owners

READ AND FOLLOW ALL INSTRUCTIONS CAREFULLY!

This spa was manufactured to meet the standards and specifications outlined in the “Virginia Graeme Baker Pool and Spa Safety Act” (VGB Safety Act). When installing and using this spa, basic safety precautions should always be followed, including:



1. **⚠ DANGER: RISK OF SEVERE INJURY OR DROWNING!**
 - Extreme caution must be exercised to prevent unauthorized access by children.
 - To avoid accidents, ensure that children do not use this spa unless supervised at all times. Adult supervision is a critical safety factor in preventing children from drowning.
 - Use the straps and clip tie downs to secure the spa cover when not in use. This will help discourage unsupervised children from entering the spa. Keep the spa cover secure in high-wind conditions.
 - There is no representation that the cover, clip tie-downs, or actual locks will prevent access to the spa.

2. **⚠ DANGER: RISK OF SEVERE INJURY OR DROWNING!**
 - Keep hair, loose articles of clothing or hanging jewelry away from suction fittings, rotating jets or other moving components to avoid entrapment that could lead to drowning or severe injury.
 - Never use the spa unless all suction guards, filter, filter lid, or skimmer assembly are installed to prevent body and/or hair entrapment.
 - Never operate or use the spa if the filter, filter lid, or skimmer assembly are broken or any part of the skimmer assembly is missing. Please contact your dealer or nearest service center for service.
 - The suction fittings and suction covers in this spa are sized to match the specific water flow created by the pump(s). If it is necessary to replace the suction fittings, suction covers or pump(s), be sure that the flow rates are compatible and are in compliance with the VGB Safety Act.
 - Never replace a suction fitting or suction cover with one rated less than the flow rate marked on the original suction fitting. Using improper suction fittings or suction covers can create a body or hair suction entrapment hazard that may lead to drowning or severe injury.

3. **⚠ DANGER: RISK OF SEVERE INJURY FROM ELECTRIC SHOCK OR DEATH FROM ELECTROCUTION!**
 - Install the spa at least 1.5m (5 feet), from all metal surfaces. As an alternative, a spa may be installed within 5 feet of metal surfaces if each metal surface is permanently connected (bonded) by a minimum No. 8.4 mm² (8 AWG) solid copper conductor attached to the wire connector on the grounding lug, inside the equipment compartment on the equipment box.

- A grounding wire connector is provided on this unit to connect a minimum No. 8.4 mm² (8 AWG) solid copper conductor between this unit and any metal equipment, metal enclosures of electrical equipment, metal water pipe, or conduit within 1.5m (5 feet) of the unit.
- Never permit any electrical appliance, such as a light, telephone, radio, television, etc. within 1.5m (5 feet) of a spa unless such appliances are built-in by the manufacturer.
- Never bring any electrical appliances into or near the spa.
- Never operate any electrical appliances from inside the spa or when you are wet.
- The electrical supply for this product must include a suitably rated switch or circuit breaker to open all ungrounded supply conductors to comply with Article 422.20 of the National Electrical Code/USA, ANSI/NFPA 70. The disconnecting means must be readily accessible and visible to the spa occupant but installed at least 1.5m (5 feet), from the spa.
- The electrical circuit supplied for the hot tub must include a suitable ground fault circuit interrupter (GFCI) as required by NEC Article 680.42.

4.  **WARNING: RISK OF SEVERE INJURY OR DEATH!**



- Extreme caution must be exercised to prevent diving or jumping into the spa or slipping and falling, which could result in unconsciousness, drowning, or serious injury. Remember that wet surfaces can be very slippery.
- Never stand, walk or sit on the top railing of the spa.





5.  **WARNING: RISK OF HYPERTHERMIA (OVER-HEATING) CAUSING SEVERE INJURY, BURNS, WELTS OR DEATH!**

- Water temperature in excess of 40°C (104°F) may be injurious to your health.
- Refer to Section 3.2 Hypertthermia for specific causes and symptoms of this condition.
- The water in the spa should never exceed 40°C (104°F). Water temperatures between 38°C (100°F) and 40°C (104°F) are considered safe for a healthy adult.
- Lower water temperatures are recommended for young children (children are especially sensitive to hot water) and when spa use may exceed 10 minutes.
- The Consumer Products Safety Commission/USA has stated that the water temperature in a spa should not exceed 40°C (104°F).
- Always test the spa water temperature before entering the spa. The user should measure the water temperature with an accurate thermometer since the tolerance of water temperature-regulating devices may vary as much as +/- (2°C 5°F).

J-LX Export

6.  **WARNING: RISK OF SEVERE INJURY OR DEATH!**
- Since excessive water temperatures have a high potential for causing fetal damage during the early months of pregnancy, if pregnant or possibly pregnant, consult your physician before using a spa.
 - Pregnant or possibly pregnant women should limit spa water temperatures to 38°C (100°F).
 - Persons suffering from obesity or a medical history of heart disease, low or high blood pressure, circulatory system problems, diabetes, infectious diseases or immune deficiency syndromes should consult a physician before using a spa.
 - If you experience breathing difficulties in association with using or operating your spa, discontinue use and consult your physician.
 - Persons using medication should consult a physician before using a spa since some medication may induce drowsiness, while other medication may affect heart rate, blood pressure, and circulation.
 - Persons suffering from any condition requiring medical treatment, the elderly, or infants should consult with a physician before using a spa.
 - The use of alcohol, drugs, or medication before or during spa use may lead to unconsciousness with the possibility of drowning.
7.  **WARNING: RISK OF SEVERE INJURY OR DEATH!**
- Prolonged immersion in a spa may be injurious to your health.
 - Observe a reasonable time limit when using the spa. Exposures at higher temperatures can cause high body temperature (overheating). Symptoms may include dizziness, nausea, fainting, drowsiness, and reduced awareness. These effects could possibly result in drowning or serious injury.
 - Never use a spa immediately following strenuous exercise. Enter and exit the spa slowly. Wet surfaces can be slippery.
8.  **WARNING: TO DECREASE RISK OF INFECTION OR DISEASE!**
- To reduce the risk of contracting a waterborne illness (e.g. an infection, bacteria or virus) and/or respiratory ailments, maintain water chemistry within the parameters listed on the inside cover of this manual and consult with a licensed engineer regarding proper ventilation if installed indoors or in an enclosed area.
 - People with infectious diseases should not use a spa to avoid water contamination, which could result in spreading infections to others.
 - Always shower before and after using your spa. Maintain water chemistry in accordance with manufacturer's instructions. Failure to do so may result in contracting a waterborne illness (e.g. an infection, bacteria or virus).

9.  **WARNING:** In addition to maintenance of filters and water chemistry, proper ventilation is recommended to reduce the risk of contracting a waterborne illness (e.g. an infection, bacteria or virus) and/or respiratory ailments that could be present in the air or water. Consult a licensed architect or building contractor to determine your specific needs if installing your hot tub indoors.
10. **CAUTION: TO DECREASE RISK OF PRODUCT DAMAGE.**
 - Maintain water chemistry in accordance with manufacturer's instructions.
 - Proper chemical maintenance of spa water is necessary to maintain safe water and prevent possible damage to spa components.
11.  **WARNING: RISK OF SEVERE INJURY OR DEATH!** The appliance is not intended for use by persons (including children) with reduced physical, sensory or mental capabilities, or lack of experience or knowledge, unless they have been given supervision or instruction concerning use of the appliance by a person responsible for their safety.
12. **NOTE:** This spa is not intended nor designed to be used in a commercial or public application. The spa buyer shall determine whether there are any code restrictions on the use or installation of this spa since local code requirements vary from one locality to another.

Hot Tub Safety

To ensure you have a safe and enjoyable hot tub experience, learn all you can about hot tub safety and emergency procedures.

The Pool & Hot Tub Alliance has a great source of safety literature.

- Go to <http://phta.org>
- Conduct your own search on the internet
- Write to the following address:

Pool & Hot Tub Alliance
2111 Eisenhower Avenue
Alexandria VA 22314
703.838.0083

J-LX Export

3.1 Entrapment Risk

The Consumer Products Safety Commission/USA has reported that users of pools and spas have become entrapped (stuck) to drain and/or suction fittings causing death, drowning, or serious injury (see diagram below). This spa was manufactured to meet the standards and specifications outlined in the "Virginia Graeme Baker Pool and Spa Safety Act" (VGB Safety Act). Entrapment risk can be minimized if proper precautions are taken.



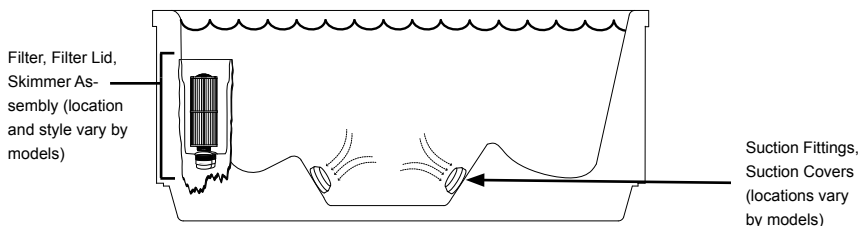

DANGER: RISK OF PERSONAL INJURY OR DEATH!

Never operate the spa if a suction fitting, suction cover, filter, filter lid, filter lid or skimmer assembly are broken, damaged or missing.



NOTE: SUCTION COVERS MUST BE REPLACED EVERY 7 YEARS.

- 1.  DANGER: RISK OF SEVERE INJURY OR DROWNING!**
Hair entrapment: May occur if hair is entangled, knotted or snagged in a drain suction or skimmer assembly. This has been reported in persons who when submerge themselves underwater, allowing hair to come close and/or within the reach of the suction fittings, suction covers or skimmer assembly.

 - Keep hair away from suction fittings, suction covers, filter, filter lid or skimmer assembly.
 - Children are at risk for hair entrapment if swimming under water.
 - Never allow children to play or get near the suction fittings, suction covers, filter, filter lid or skimmer assembly.
- 2.  DANGER: RISK OF SEVERE INJURY OR DROWNING!**
Limb entrapment: May occur when a limb becomes entrapped, inserted or sucked into a suction or outlet opening.

 - Always keep suction fittings, suction covers, filter, filter lid or skimmer assembly in place when operating to avoid limb entrapment.
 - Never allow children to play or get near the suction fittings, suction covers, filter, filter lid or skimmer assembly.
- 3.  DANGER: RISK OF SEVERE INJURY OR DROWNING!** Body entrapment.

 - Do not insert fingers in massage jet nozzle.



4.  **DANGER: RISK OF SEVERE INJURY OR DROWNING!**
Body entrapment: May occur when part of the torso becomes entrapped, inserted or sucked into a suction or outlet opening.
 - Never allow children to play or get near the suction fittings, suction covers, filter, filter lid or skimmer assembly.

5.  **DANGER: RISK OF SEVERE INJURY OR DROWNING!**
Evisceration (disembowelment) entrapment: May occur when the buttocks becomes entrapped, inserted or sucked into a suction or outlet opening.
 - Never sit on suction fittings, suction covers, filter, filter lid or skimmer assembly.
 - Never allow children to play or get near the suction fittings, suction covers, filter, filter lid or skimmer assembly.

6.  **DANGER: RISK OF SEVERE INJURY OR DROWNING!**
Mechanical entrapment: May occur when jewelry, swimsuit, or hair accessories become entangled, knotted or snagged in a drain suction or skimmer assembly.
 - Never allow your jewelry, swimsuit, or hair accessories to come close to the suction fittings, suction covers or skimmer assembly.
 - Never allow children to play or get near the suction fittings, suction covers, filter, filter lid or skimmer assembly.

3.2 Hyperthermia

Prolonged immersion in hot water may induce hyperthermia (overheating). The use of alcohol or drugs can greatly increase the risk of fatal hyperthermia in spas. A description of the causes, symptoms, and effects of hyperthermia are as follows:

Hyperthermia occurs when the internal temperature of the body reaches a level several degrees above the normal body temperature of 37°C (98.6°F). The symptoms of hyperthermia include drowsiness, lethargy (fatigue), and an increase in the internal temperature of the body (feeling of being too hot). The effects of hyperthermia include:

- Unawareness of impending hazard;
- Failure to perceive heat;
- Failure to recognize the need to exit spa;
- Physical inability to exit spa;
- Fetal damage in pregnant women; and
- Unconsciousness and DANGER of drowning.

A Warning Sign is provided in your warranty packet. Please install at a location near your spa, where it is visible to users of the spa. For additional or replacement Warning Signs please contact your local Jacuzzi dealer and reference item number #6530-082.

J-LX Export

3.3 PRECAUTIONS-Important Chemical Safety

Do not use this device with bromide products.

3.4 PRECAUTIONS FOR USE OF PRODUCTS CONTAINING SODIUM BROMIDE

- Do not use any Product containing Sodium Bromide with an electrolysis device (for example, a chlorine generator).
- Do not use any Product containing Sodium Bromide with ozonation.
- Do not use any Product containing Sodium Bromide with ultraviolet (UV).

3.5 Important Additional Safety Instructions

When using this electrical equipment, basic safety precautions should always be followed, including the following:

1. **READ AND FOLLOW ALL INSTRUCTIONS.**
2. A green colored terminal or a terminal marked G, Gr, Ground, Grounding or the  symbol* is located inside the supply terminal box or compartment. To reduce the risk of electric shock, this terminal must be connected to the grounding means provided in the electric supply service panel with a continuous copper wire equivalent in size to the circuit conductors that supply this equipment (*IEC Publication 417, Symbol 5019).
3. At least two lugs marked “Bonding Lugs” are provided on the external surface or on the inside of the supply terminal box/compartment. To reduce the risk of electric shock, connect the local common bonding grid in the area of the spa to these terminals with an insulated or bare copper conductor not smaller than No. 10 mm² (6 AWG).
4. All field installed metal components such as rails, ladders, drains or other similar hardware within 3m (10 feet) of the spa shall be bonded to the equipment grounding buss with copper conductors not smaller than No. 10 mm² (6 AWG).
5. **SAVE THESE INSTRUCTIONS.**

3.6 General Electrical Safety Instructions

Your new Jacuzzi spa is equipped with a “state-of-the-art” equipment system. It contains the most advanced safety and self-protective equipment in the industry. Nonetheless, this spa must be installed properly to ensure dependable usage. Please contact your local Jacuzzi dealer or local building department should you have any questions regarding your installation.

Proper grounding is extremely important. Jacuzzi spas are equipped with a current collector system. A pressure wire connector is provided on the surface of the control box, located outside the equipment door (Figure C, page 14) to permit connection of a bonding wire between this point and any ground metal equipment, metal water pipe or conduit within 1.5m (5 feet) of the spa, or copper clad grounding rod buried within 1.5m (5 feet) of the spa. Bonding wire must be at least No. 8.4 mm² (8 AWG) solid copper wire. This is a most important safety assurance feature. Before installing your spa, check with your local building department to insure installation conforms to local building codes.

4.0 Choosing A Location

IMPORTANT: Because of the combined weight of the spa, water and users, it is extremely important that the base upon which the spa rests be smooth, flat, level and capable of uniformly supporting this weight, without shifting or settling, for the entire time the spa is in place. Visit www.Jacuzzi.com for information. If the spa is placed on a surface which does not meet these requirements, damage to the skirt and/or the spa shell may result. Damage caused by improper support is not covered under warranty. It is the responsibility of the spa owner to assure the integrity of the support over time. We recommend a poured, reinforced concrete slab with a minimum thickness of 10 cm (4 inches). Wood decking is also acceptable provided it is constructed so that it meets the requirements outlined above.



WARNING: For spas that are to rest on balconies, roofs or other platforms not specifically tied into main structural support, consult a professional Structural Engineer with experience in this type of application.



WARNING: Proper drainage is required. The installation must not allow the spa equipment bay to become flooded or wetted (by external water). It is your responsibility, and the responsibility of any installation contractor you hire, to make sure that all applicable codes and/or local construction requirements are met. If in doubt, refer to the building authority responsible for approving the proposed installation site.

The spa must be installed in such a manner as to provide drainage away from it. Placing the spa in a depression without provisions for proper drainage could allow rain, overflow, leaks from spa plumbing, and other casual water to flood the equipment and create a wet condition in which it would sit in. For spas which will be installed below grade or recessed into a floor or deck, install so as to permit access to the equipment, either from above or below, for servicing. Make certain that there are no obstructions which would prevent removal of all side cabinet side panels and access to the jet components, especially on the side with the equipment bay.



CAUTION: If the spa is indoors or located in an enclosed area, proper ventilation should be discussed with an Engineer or authority competent enough to understand the necessary provisions needed to vent moist or heated air and air associated with chemical odors outdoors. **When the spa is in use considerable amounts of moisture will escape potentially causing mold and mildew.** This can cause health risk. Over time, this can damage certain surfaces, surroundings, and equipment.

J-LX Export

4.1 Outdoor Location

In selecting the ideal outdoor location for your spa, we suggest that you take into consideration:

- The proximity to changing area and shelter (especially in colder weather).
- The pathway to and from your spa (this should be free of debris so that dirt and leaves are not easily tracked into the spa).
- The closeness to trees and shrubbery (remember that leaves and birds could create extra work in keeping the spa clean).
- A sheltered environment (less wind and weather exposure can result in lowered operation and maintenance costs).
- The overall enhancement of your environment. It is preferable not to place the spa under an unguttered roof overhang since run-off water will shorten the life expectancy of the spa cover.
- For spas that are to rest on balconies, roofs or other platforms not specifically tied into main structural support, consult a professional Structural Engineer with experience in this type of application.
- In the unlikely event that you should ever need to access or gain entry to any portion of the spa for servicing, it is highly recommended that you plan your outdoor installation to provide full access to the entire spa. Please take this into consideration when placing the spa in a deck or enclosed by a surrounding.
- Consider locating your spa away from any reflective surface or glass to prevent any damage to the synthetic skirt.
- Do not shim the spa. To ensure proper support the spa must sit flat on the intended foundation.

4.2 Indoor Location

For indoor installations many factors need to be considered before installing a spa indoors:



WARNING: In addition to maintenance of filters and water chemistry, proper ventilation is recommended to reduce the risk of contracting a waterborne illness (e.g. an infection, bacteria or virus) and/or respiratory ailments that could be present in the air or water. Consult a licensed architect or building contractor to determine your specific needs if installing your hot tub indoors.

- **Proper Foundation: Consult a Structural Engineer when considering a foundation that will adequately support the spa the entire time it is in place.** Proper support is critical especially if the spa is to rest on a second story or higher. For spas that are to rest on balconies, roofs or other platforms not specifically tied into the main structural support, you should consult a professional Structural Engineer with experience in this type of application.

- **Proper Drainage: It is extremely important to have in place measures to sufficiently handle excessive water spillage.** Be sure the flooring in which the spa rests on has adequate drainage and can handle the entire contents of the spa. Be sure to make provisions for ceilings and other structures that may be below the spa installation. Areas around your spa can become wet or moist so all flooring and subsequent furniture, walls and adjacent structures should be able to withstand or resist water and moisture.
- **Proper Ventilation: Proper ventilation should be discussed with an Engineer or authority competent enough to understand the necessary provisions needed to vent moist or heated air and air associated with chemical odors outdoors.** When the spa is in use considerable amounts of moisture will escape, potentially causing mold and mildew over time which can damage certain surfaces and/or surroundings.
- **Sufficient Access:** In the unlikely event that you should ever need to access or gain entry to any portion of the spa for servicing, it is highly recommended that you plan your indoor installation to provide full access to the entire spa.
- **Warranty:** Damage caused by not following these guidelines or any improper installation not in accordance to local codes or authorities is not covered under the spas warranty. Please consult your local state or city building ordinances.
- **Do not shim the spa.** To ensure proper support the spa must sit flat on the intended foundation.

5.0 General Electrical Safety Instructions

Your new Jacuzzi spa is equipped with a “state-of-the-art” equipment system. It contains the most advanced safety and self-protective equipment in the industry. Nonetheless, this spa must be installed properly to insure dependable usage. Please contact your dealer or local building department should you have any questions regarding your installation.



Proper grounding is extremely important. Jacuzzi spas are equipped with a current collector system. A pressure wire connector is provided on the surface of the control box, located outside the equipment door (Figure C, page 14) to permit connection of a bonding wire between this point and any ground metal equipment, metal water pipe or conduit within 1.5m (5 feet) of the spa, or copper clad grounding rod buried within 1.5m (5 feet) of the spa. Bonding wire must be at least No. 8.4 mm² (8 AWG) solid copper wire. This is a most important safety assurance feature. Before installing this spa, check with the local building department to insure installation conforms to local building codes.

J-LX Export

6.0 Electrical Wiring Instructions

IMPORTANT NOTICE: The electrical wiring of this spa must meet the requirements of any applicable state or local codes. The electrical circuit must be installed by a qualified electrician and approved by a local building/electrical inspection authority.

1.  **DANGER: TO DECREASE THE RISK OF SHOCK, PRODUCT DAMAGE OR ELECTRICAL FIRE!**
This spa must be permanently connected (hard-wired) to the power supply. **No plug-in connections or extension cords are to be used in conjunction with the operation of this spa.** Supplying power to the spa, which is not in accordance with these instructions, will void both the independent testing agency listing and the manufacturer's warranty.
2. The power supplied to this spa must be a dedicated circuit with no other appliances or lights sharing the power provided by the circuit.
3. To determine the current, voltage and wire size required, refer to Section 7.0 "Power Requirements" (page 16).
 - Wire size must be appropriate per local codes.
 - The spa controller's terminal block will accept a maximum wire size of 10 mm² (6 AWG).
4. The electrical supply for this product must include a suitably rated switch or circuit breaker to open all ungrounded supply conductors to comply with local building/electrical inspection authority. The disconnecting means must be readily accessible to the spa's occupant but installed at least 1.5m (5 feet) from spa water.
5. The electrical supply for this product must include a suitably rated isolating switch and circuit breaker to comply with local electrical regulations. This RCD/GFCI circuit breaker must be installed at the power supply in the house electrical box.
6. For Australia/New Zealand, the spa should be supplied through a residual current device (RCD) with a rated tripping current not exceeding 30mA (IEC 60335-2-60). The spa is not intended for use at altitudes exceeding 2000m.
7. To gain access to the spa's power terminal block:
 - Grab one of the corner panels, from the bottom, where it touches the bottom pan. Then gently pull the panel forward to unsnap it from the holding clip, Figure A. Repeat the step for the top of the corner panel. Place the panel in a safe location to prevent from damaging it. Repeat the steps to remove the other corner panel.
Note: The corner exterior lights on the panels are connected to the light wires. Take care when removing the corner panels to avoid damaging the wires. Make sure to disconnected cable A from cable B Make sure to disconnected cable A from cable B, Figure A.
 - Grab the bottom of the front panel and slightly lift to release it from the top mount. Tilt the panel and pull down to remove, Figure A. Place the panel in a safe location to prevent from damaging it.

8. Select the power supply inlet you want to use (Figure B). Make sure to install a 3/4" electrical fitting and conduit through the large opening provided in the bottom of the control box so you can feed the cable through to the terminal block.
9. Connect wires, color to color, on terminal blocks TB1 and TB3 (Figure C, page 14). **TIGHTEN SECURELY!** All wires must be hooked up securely or damage could result.
10. Reinstall the control box door, then reinstall the front panel and cabinet corners.

Note: Exposure of the cabinet to heat could cause the cabinet to warp. Should the cabinet warp, once it is installed, the warping is not visible. However, it does make the removal and replacement a little more challenging.

Figure A
Removing the Front panel

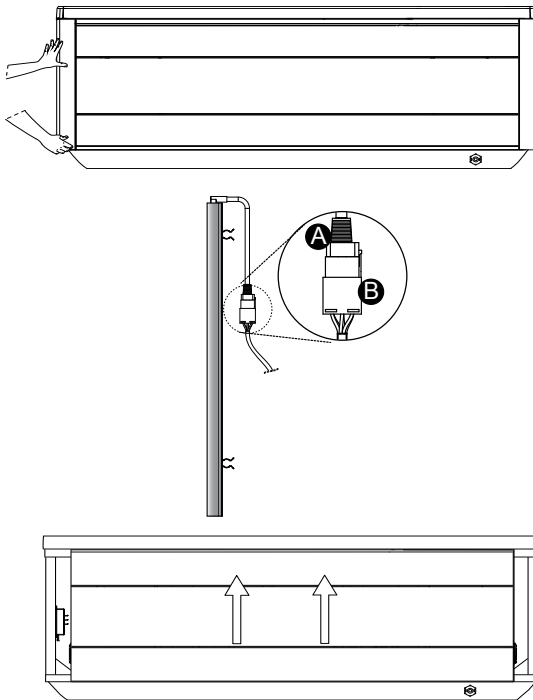

**Figure B
Equipment Area**

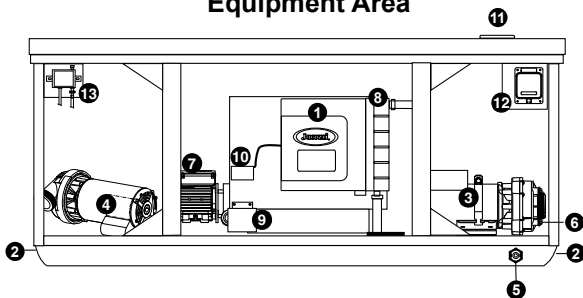

Note: Equipment location (such as pumps, ClearRay® unit, drain, heater etc.) varies by model.

- | | |
|-----------------------------|--------------------------------|
| 1. Control Box | 8. Heater |
| 2. Power Supply Entrance(s) | 9. ClearRay® UV Unit |
| 3. Jets Pump | 10. ClearRay® Ballast |
| 4. Jets Pump | 11. Control Panel |
| 5. Spa Drain Valve | 12. SmartTub Module (optional) |
| 6. Pump Drain Plug(s) | 13. Ozone |
| 7. Circulation Pump | |

**Figure C
Control Box**

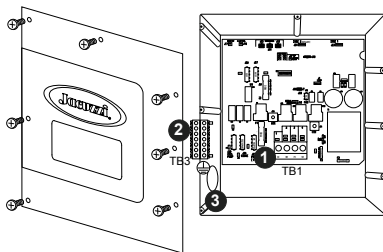

1. Main Terminal
2. Bonding Lug/Grounding Terminal
3. Power wires entrance (electrical fitting and conduit must be installed)

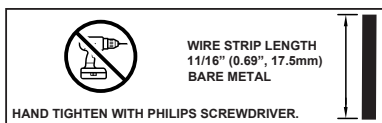
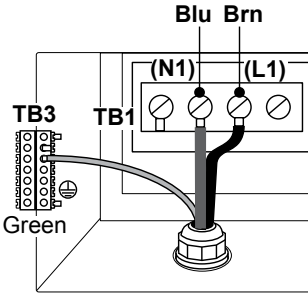

Figure D
(Terminal Block 230V/50z Wire Connection)
[refer to page 61 for wiring diagram]

***IMPORTANT NOTE:** Wire connections on controller board must be changed depending on the number of breakers being used, pages 64 and 65.



Factory Default

Service 1

- Brn (L1)**
- Blu (N1)**

BREAKER TERMINAL CONNECTIONS

L1 = All Components

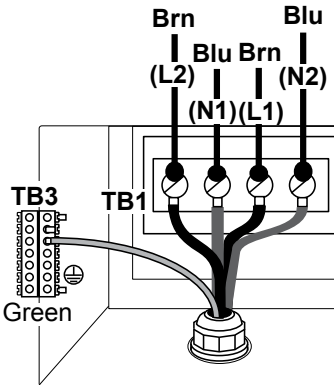

Service 1

- Blu (N1)**
- Brn (L1)**

Service 2

- Brn (L2)**
- Blu (N2)**

BREAKER TERMINAL CONNECTIONS

L1 = Heater and transformer
 L2 = All other components

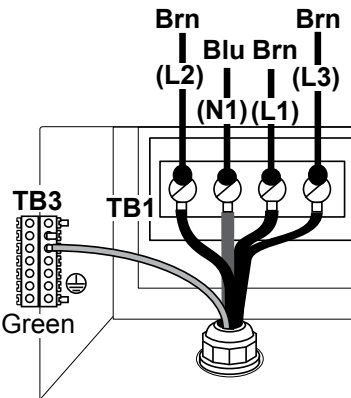

Service 1

- Blu (N1)**
- Brn (L1)**

Service 2

- Brn (L2)**

Service 3

- Brn (L3)**

BREAKER TERMINAL CONNECTIONS

L1 = Heater and transformer
 L2 = Pump 1 and other components
 L3 = Pump 2, Stereo, and ClearRay

J-LX Export

7.0 Power Requirements

Jacuzzi spas are designed to provide optimum performance and flexibility of use when connected to the maximum electrical service listed below. Minor circuit board modifications can be performed to allow your new spa to accept an electrical service other than the factory operation setting.

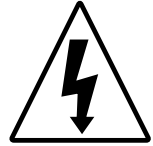

Note: Refer to page 61 for circuit board configuration details or contact your authorized Jacuzzi dealer.

Export 50 Hz (1 Breaker Connection)

	Single Breaker Service 1 (including Heater)*	Single Breaker Service 1 (including Heater)**
Voltage:	230 VAC	230 VAC
Max. Current Draw:		
2-Pump System	17A	29A
Wattage:		
2-Pump System	3.9kW	6.7kW
Frequency:	50 Hz	50 Hz
Number of Wires:	3	3

Single breaker configuration is the factory default.

- * In this configuration, the heater **will not operate** while any jets pump is running. The service 1 breaker will include connection for all components.
- ** In this configuration, the heater **will operate** while one or two jets pumps are running. The service 1 breaker will include connection for all components.

Export 50 Hz (Two and Three Breaker Connections)

	Dual Service Breakers Service 1/Service 2 Breaker***	Three Service Breakers Service 1 /Service 2/ Service 3 Breaker****
Voltage:	230 VAC	230 VAC
Max. Current Draw:		
2-Pump System	13A/17A	13A/9A/9A
Wattage:		
2-Pump System	3.0KW/3.9kW	3.0kW/2.1kW/2.1kW
Frequency:	50 Hz	50 Hz
Number of Wires:	5	5
<p>*** In this configuration, the heater will operate while two jets pumps are running. The service 1 breaker will include connections for the heater and transformer. The service 2 breaker is for all other components.</p> <p>**** In this configuration, the heater will operate while all jets pumps are running. The service 1 breaker will include connections for the heater and transformer. Service 2 breaker is for pump 1 and other components. Service 3 breaker is for pump 2.</p>		

8.0 Spa Fill Up Procedure

For best results, read each step in its entirety before proceeding with that step. Make sure all drains and drain plugs are closed before filling.

1. Prepare The Spa For Filling

- Clear all debris from the spa. (Although the spa shell has been polished at the factory, you may want to treat it with a specially formulated spa cleaner.) Consult your authorized Jacuzzi dealer for additional information prior to filling spa.
- If using the primary filter fitting to fill, remove filter cover, then remove filter cartridge as outlined in Section 13.1 (page 41).

IMPORTANT: In most cases, filling the spa by placing the hose in the footwell will not create an airlock, page 59. If you experience an airlock we recommend filling by placing the end of your garden hose into the primary filter fitting inlet. This wall fitting is the one with the grid, page 41.

J-LX Export

2. Fill Spa

- Place the end of your garden hose into the empty filter fitting or into the footwell. Fill until water covers all jets but does not touch the bottom of the lowest headrest.

CAUTION: TO DECREASE BUILD UP ON COMPONENTS AND MINIMIZE ACRYLIC DAMAGE.

Never fill with water from a water softener. If your water is extremely “hard”, it is preferable to fill half-way with hard water and the rest of the way with softened water. Water that is too soft can be corrosive to metal components.

•  **WARNING: TO DECREASE RISK OF INFECTION OR DISEASE.**

Fill hot tub with clean tap water from garden hose to reduce risk of contracting a waterborne illness (e.g. an infection, bacteria or virus) and/or respiratory ailments. Fill until water covers all jets but does not touch the bottom of the lowest headrest. (DO NOT OVERFILL!)

3. Turn On Power

Turn on power to spa at the home's circuit breaker to start boot up sequence (Sec. 10.0, page 23). The heater and filter pump will automatically activate after several seconds. Refer to page 56 for additional information.

4. Activate Jets Pumps

Turn on jets pump(s) to ensure proper mixing when adding start-up chemicals in step 5.

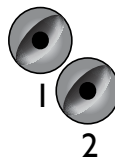

5. Add Start-Up Chemicals

Add the spa water chemicals as recommended by your authorized Jacuzzi dealer. Section 13.0 “Water Quality Maintenance” (page 49) for general guidance.



WARNING: RISK OF POISONING OR DEATH.

Never leave chemicals opened and accessible to anyone. Use chemicals according to the vendors instructions. Always store chemicals in a safe and/or locked location. Keep away from and out of reach of children.

6. Establish A Stable Sanitizer Reading

Establish a stable sanitizer reading of no less than 1.0 ppm free chlorine or 2.0 ppm bromine. To ensure healthy water conditions, always maintain a constant sanitizer reading within the levels recommended on the inside cover of this manual.



7. Set Spa To Heat

To warm spa water to a comfortable temperature, follow these steps:

- The LED display on the control panel displays the actual temperature of the spa water. Press either the **COOLER** (▾) or **WARMER** (▲) button once to display the “set” temperature for 5 seconds. If you want the water to heat to a different temperature, simply press **COOLER** (▾) or **WARMER** (▲) within 5 seconds. The set temperature increases or decreases by one degree each time one of these buttons is pressed.
- The heater will turn off when the temperature corresponding to the thermostat setting is achieved.

Important Heater Details:

- The maximum water temperature setting for your spa is 40°C (104°F) and the minimum setting is 18°C (65°F).
- Setting the thermostat at maximum will not accelerate the heating process. This will only result in a higher ultimate temperature.
- The heater operates until the water reaches the programmed “set temperature”, then turns off. The heater will reactivate after the water cools to approximately 1°C (2°F) below the set temperature.

8. Place Cover On Spa

- Keeping the insulating cover in place anytime the spa is not in use will reduce the time required for heating, thereby minimizing operating costs.
- The time required for initial heat-up will vary depending on the starting water temperature.



DANGER: RISK OF PERSONAL INJURY.

Check water temperature carefully before entering hot tub! Excessive water temperature can cause burns, welts and body temperature to rise, hyperthermia (over-heating).

Decontamination Procedure (Steps 9-15)

Steps 9-15 below are only required when sanitizer levels are unstable after performing steps 1-6 above. Disregard steps 9-15 below if sanitizer levels remain stable after performing steps 1-6 above (refer to the inside cover of the manual).

Note: The “decontamination procedure” steps 9-15 should also be used after the spa has been “Winterized” (Section 13.9, page 48) or has been sitting without power for an extended period.

- 9. Add 71 g. (2.5 ounces) of sodium dichlor for every 378 litres (100 gallons) of water. Refer to the following table for approximate water fill volume by model.

J-LX Export



CAUTION: RISK OF PERSONAL INJURY OR SPA DAMAGE!

Never add chlorine tablets (trichlor) or acid to your hot tub for any reason! These chemicals may damage components within your hot tub, burn or irritate your skin, create a rash, and void the manufacturer warranty for your spa.

Water Fill Volume by Model

Spa Model	Average Fill Volume*	Sodium Dichlor
J-LX	1,261 L (333 Gal)	237 g
J-LXL	1,268 L (335 Gal)	238 g

*Use average fill volume for chemical maintenance

10. Leave spa cover open during this step to allow excessive chemical vapors to exit spa, protecting pillows and plastic knobs from chemical attack. If spa is indoors, open doors and windows for proper ventilation. Turn on all jet pumps for one hour, then place the massage selector knob in the center “combo” position and open all air controls.



Note: You will need to press the jets pump button(s) every 20 minutes since these functions have an automatic 20 minute time-out function that turns them off.



WARNING: RISK OF PERSONAL INJURY!

- To decrease the risk of injury, drowning or entrapment, never leave your hot tub unattended for any reason while the cover is open and accessible, especially to small children and animals!
- Precautions should be taken to minimize your exposure to chemical vapors (that could cause lung, brain, or skin damage).

11. Turn off power to the spa at the circuit breaker, then drain spa as outlined in Section 13.2 “Draining and Refilling” (page 45).
12. Fill spa until water covers all jets but does not touch the bottom of the lowest headrest. **DO NOT OVERFILL.**

CAUTION: TO DECREASE BUILD UP ON COMPONENTS AND MINIMIZE ACRYLIC DAMAGE.

Never fill with water from a water softener. If your water is extremely “hard”, it is preferable to fill half-way with hard water and the rest of the way with softened water. Water that is too soft can be corrosive to metal components.

13. Consult your authorized Jacuzzi dealer for chemical recommendations, then add chemicals to hot tub water to achieve a constant sanitizer reading within the levels recommended on the inside cover of this manual.
14. Turn on jet pumps when adding chemicals to ensure proper mixing and leave your hot tub cover open until the sanitizer level becomes stable to protect pillows and plastic knobs from chemical attack. Refer to the inside cover of the manual.



WARNING: RISK OF PERSONAL INJURY.

- To decrease the risk of injury, entrapment or drowning, never leave your hot tub unattended for any reason, especially if while the cover is open and accessible to small children and animals!
- To decrease the risk of contracting a waterborne illness (e.g. an infection, bacteria or virus) and/or respiratory ailments, maintain water chemistry within 6 step parameters. If you or other bathers experience such a condition, discontinue use and seek immediate medical attention.

15. Establish a sanitizer reading no less than 1.0 ppm free chlorine or 2.0 ppm bromine, then allow the hot tub to set undisturbed for 8 hours. Retest water after 8 hours to determine if sanitizer levels are stable. If sanitizer levels are stable, your spa is ready for use. To ensure healthy water conditions, always maintain a constant sanitizer reading within the levels recommended on the inside cover of this manual. If sanitizer levels are not stable at this time, it will be necessary to repeat this procedure in its entirety (steps 1-15) until stable sanitizer readings are achieved.

IMPORTANT: If the ClearRay Active Oxygen® system is removed from the hot tub or is not operating effectively follow the “without ClearRay®” water chemistry parameters as defined by the Pool & Hot Tub Alliance.

16. After adequate sanitizer levels are achieved, close all spa air controls to maximize heat retention when spa is not in use.

J-LX Export

9.0 Spa Features

9.1 General Spa Features And Controls

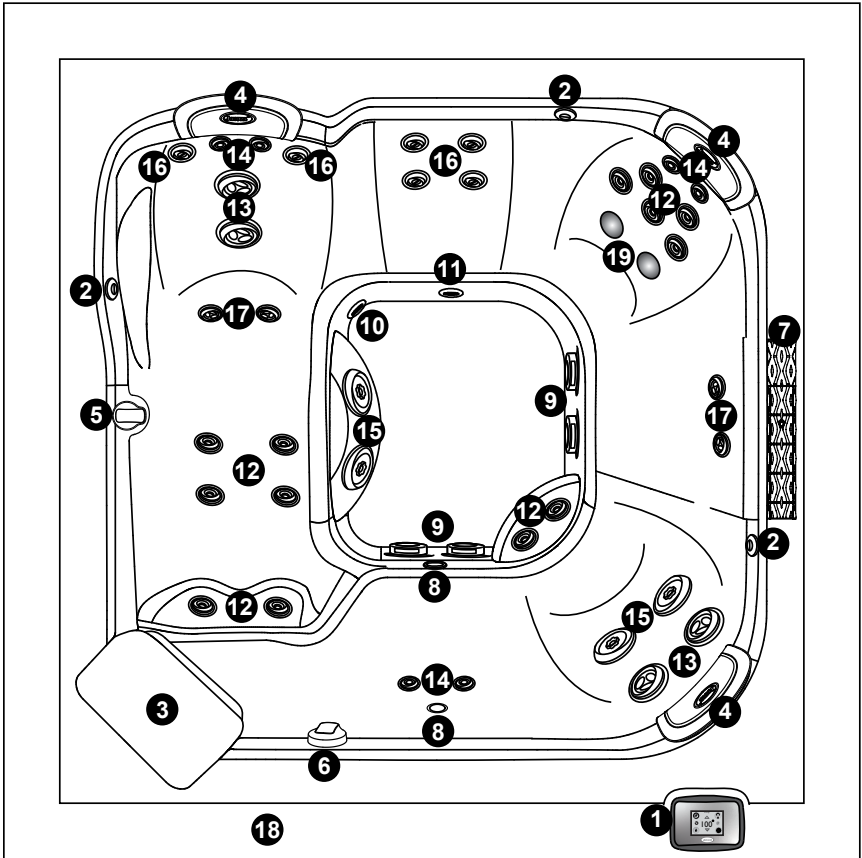

J-LXL model shown

- | | |
|-----------------------------------|-------------------------------------------|
| 1. Control Panel | 11. Waterfall Dump Port |
| 2. Toggle Air Controls (3) | 12. PowerPro FX Jets (17) |
| 3. Filter/Skimmer Grill | 13. PowerPro FX Large Rotational Jets (4) |
| 4. Pillows (3) | 14. PowerPro NX2 Jets (6) |
| 5. Massage Selector Valve | 15. PowerPro MX Jets (4) |
| 6. Waterfall Valve (side mounted) | 16. PowerPro RX Jets (6) |
| 7. Waterfall | 17. PowerPro FX Rotational (4) |
| 8. Spa Light | 18. Top Rail |
| 9. Footwell Suction Fittings (4) | 19. IR and Red Light (2) |
| 10. Heater Return Fitting | |

Specifications/features subject to change without notice.

10.0 Registration and Start-up

10.1 Start-up Sequence

During the start-up sequence, the welcome screens will appear, Figure 10.1a. Then a blow out cycle will begin, page 34. After the cycle ends, the hot tub will display the Home Menu.

Note:

- The start up menu will time out after approximately 3 seconds.
- The exterior lights flash on and off to indicate a connection.

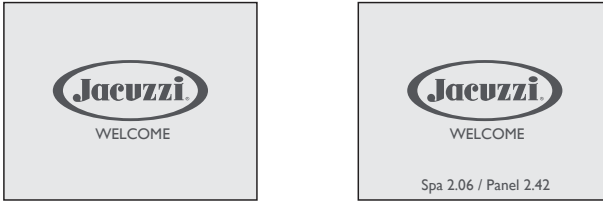

Figure 10.1a

10.2 Register Your New Spa

Registering your spa is important in order to validate your warranty. To register you will need to have the spa serial number, Figure 10.2a, then you will need to register online at www.Jacuzzi.com.

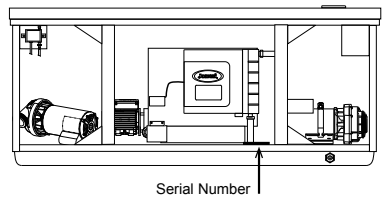

Figure 10.2a

Follow these steps to register your spa.

1. Using your home computer or other device, connect to the internet.
2. Go to www.Jacuzzi.com website to register your spa.
3. Click **Outdoor Hot Tubs**
4. Click **For Owners**
5. Click **Warranty and Manuals**
6. Click **Warranty Registration**
7. Enter your serial number.

Keep a record of your serial number for any future reference. Write that information below.

Serial Number: _ _ _ _ _

J-LX Export

10.3 ProTouch™ Control Panel

The ProTouch system makes operating your spa a breeze. You can navigate through the menus and sub-menus with ease. Simply touch the icons on the LCD display to begin operating your new Jacuzzi spa.

A. Home Menu Control Buttons



The Home Menu, Figure 10.3a, provides access to spa functions and programming. Operation is made easy by the interactive control panel. If there is no activity for 30 minutes, the LCD display will time-out into a sleep mode. To reactivate the display, just tap the display screen. When a feature is on, the button will have a blue inner glow.



Figure 10.3a



= **Temperature Control:** Allows you to adjust the set temperature of the spa:

- Increase the temperature by tapping  in 0.5°C (1°F) increments.
- Decrease the temperature by tapping  in 0.5°C (1°F) increments.

Note: The temperature range for the spa is 18.33 to 40°C (65 to 104°F). To activate the **Extended Temperature feature** that allows the spa to reach 41°C (106°F), page 58.



= **Jet Button:** Tap to access the menu to operate the jets pump, page 25.



= **Light Button:** Tap to access the menu to operate the lighting options, page 26.



= **ClearRay® Button:** Tap to activate the ClearRay Active Oxygen® System on demand feature, page 27.



= **Settings Button:** Tap to access the programming and setting menus, page 30.



= **Error Indicator Icon:** Displays when there is an error message that needs to be addressed. The icon will also appear under the Temperature reading as a reminder, page 55. Tap to view the condition that requires attention.



= **Invert Button:** Tap to invert the display image.



= **Heater ON icon:** Will display when the heater is on.



= **Lock Button:** Displays when one of the lock modes is enabled, page 37.



= **Wi-Fi icon:** Will display when the Wi-Fi feature is on page 37. Not applicable if the optional SmartTub® system is installed.

6:45p = **Time Indicator:** The time will always be shown when the Home Menu is displayed. The appearance will vary depending on whether the clock is set to a 12-Hour or 24-Hour configuration, page 39. The default setting is 12-Hour.

Note: The time does NOT automatically adjust for daylight saving time. The time must be manually adjusted.

11.0 Operating Instructions

11.1 ProTouch™ Control Panel

Your Jacuzzi spa is equipped with a ProTouch control panel; massage selectors, and air control knobs. These controls let you operate many of the special functions of your Jacuzzi spa.

11.2 Activating the Jets Pumps

From the Home Menu, (Figure 11.2a), tap  to enter the Jets Pump Submenu. The panel will display the Jets Pump Submenu (Figure 11.2b).

Note: Once you enter the Jets Pump Submenu, all the pumps will activate. You can turn off the jets pump by tapping the jets pump button.



Figure 11.2a

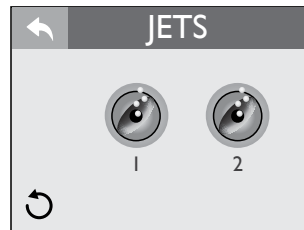

Figure 11.2b



= **Jets Pump 1 Button**



= **Jets Pump 2 Button**

J-LX Export



= **Back Button:** Tap to go back to the previous menu.



= **Invert Button:** Tap to invert the display image.

1. Tap the Jets 1 button to turn the pump on and off.
2. Tap the Jets 2 button to turn the pump on and off.



JETS ICON
WHEN ON





JETS ICON
WHEN OFF

Note:

- When a jets pump is on, the button will have a blue inner glow.
- Auto Turn Off — Anytime a pump has been manually turned on, it will automatically turn off after approximately 20 minutes. If at this time you desire more jet operation you may simply turn the pump(s) back on.

11.3 Lights Menu

From the Home Menu, (Figure 11.3a), tap  to enter the Light submenus. The LCD screen will display the Light Submenu (Figure 11.3b). From this menu you can control the hot tub lighting. When you tap  to enter the submenu, the lights will turn on, if not on already, in a color blending mode. Default settings are brightness level at 0 and speed setting of 0.

Note: The interior lights automatically turn off after 2 hours. They can be reactivated if needed.

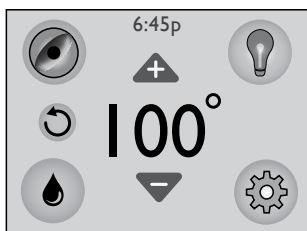

Figure 11.3a

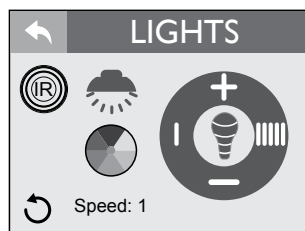

Figure 11.3b



= **Brightness Up Button:** Tap to raise the intensity of the lights to the maximum level of 5. The intensity levels are as follows: 5 = 100%, 4 = 80%, 3 = 60%, 2 = 40% and 1 = 20%, 0 = 0%.



= **Brightness Down Button:** Tap to lower the intensity of the lights to the minimum level of 0.



= **Intensity Indicator:** Displays the current intensity level of the lights by the number of bars filled in. This will only work with the solid color option. If the blending mode is on, the light bulb is grayed out. The range is from 0 to 5.



= **Speed Control Button (Increase):** Tap to increase the blending speed, of the colors, to the maximum speed of 5. The speed settings are as follows: 5 = every 5 secs, 4 = every 10 secs, 3 = every 15 secs, 2 = every 30 secs and 1 = every 60 secs.



= **Speed Control Button (Decrease):** Tap to decrease the blending speed, of the colors, to the minimum speed of 0.

Speed: |

= **Speed Selector Icon:** Tap  or  to select the blending speed for the light colors.



= **Color Selector:** Tap a color to select a single color.







= **Back Button:** Tap to go back to the previous menu.



= **Invert Button:** Tap to invert the display image.



= **Exterior Light Button:** The exterior corner lighting has 4 settings. The lights display a solid White color only. By continually tapping  you will scroll through the following:

1.  **OFF:** Exterior lights are turned off.
2.  **ON:** Solid White color with a 100% intensity level.
3.  **MID:** Solid White color with a 50% intensity level.
4.  **AUTO:** Solid White color with a 100% intensity level.

Lights are on from 7:00 pm to 12:00 am.

Note: The exterior lights automatically turn off after 8 hours, except for the AUTO setting.



= **IR and Red Light:** Press to begin the 20 minute session.

11.4 ClearRay on Demand

The ClearRay Active Oxygen® on demand feature activates the water purification system. Continuously tap  to activate the system for 1 hour, 2 hours, 3 hours or OFF. During this time the circulation pump and the ClearRay Active Oxygen® system are on.

Note: When the ClearRay Active Oxygen® system is on due to a programmed or scheduled setting the feature cannot be turned off.

11.5 Ozone Operation

The Ozonator will activate anytime the circulation pump is on during the Primary Filter Cycle or heat call.

Note: DO NOT press either JETS button, this will shut off the ozone for the amount of time the jets are on plus 5 minutes after they shut off.

11.6 Adjusting Jet Flow

The water flow to certain jets in your spa can be increased or decreased by rotating the outside jet face.

Note: Always keep at least 6 adjustable jets open at all times.



11.7 Adjusting PowerPro™ MX Jets

Tilt PowerPro MX Jet nozzle to angle of choice as desired. Rotate nozzle clockwise to reduce flow volume from jet or rotate counterclockwise to increase flow volume.

Note: Always keep at least 6 adjustable jets open at all times.



J-LX Export

11.8 Adjusting RX Jets

Rotate the outside jet face clockwise to decrease or shut off water flow. Turn counterclockwise to turn on or increase water flow.

Note: Always keep at least 6 adjustable jets open at all times.



11.9 Waterfall Control

Turn waterfall control valve counterclockwise to increase waterfall output. Turn control valve clockwise to decrease or turn off waterfalls.

Note: When the waterfall is in the OFF position, some water may still flow through. This is considered normal.



11.10 Air Controls

Certain jet systems have their own “toggle” on/off air control.

Each control introduces air into the water lines that supply specific jet groups. Simply press any air control button to open or press the opposite side of button to close. To minimize heat loss, all air controls should be closed when the spa is not in use.

Note: Certain jets may draw air even though they are closed. This is considered normal.



11.11 Selecting the Desired Massage Action

Your Jacuzzi spa is equipped to allow you to customize the massage action you desire. Each model incorporates a massage selector that allow you to customize the massage and performance by diverting water between various jet systems. Simply turn massage selector to position A (Combo), B, or C to divert water pressure to various jet groups.

Note: The massage selector valve(s) is designed to operate in positions A (Combo), B, and C for optimum performance. It is considered normal for sound levels within the valve to vary between positions due to the large amounts of water flowing through it. For optimum filtration benefits, leave the valve in position A when spa is covered. Select position B or C for maximum jet performance during spa use.



11.12 IR and Red Light Therapy

Exclusive patented Infrared technology only in a Jacuzzi® hot tub. Located in the lower back of the FX Therapy seat to aid in the relief of muscle pain. Infrared uses specific wavelengths of light to penetrate below skin to deep tissue.

Note: The IR and Red light device used in this spa has been tested both in a dry and submerged state by certified Intertek® test laboratories. Testing was conducted for this device to the IEC 62471 – Photobiological Safety Standard. Results place this device in the Risk Group 0 (RG0) exempt category.



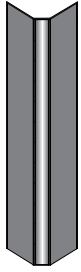

11.13 Exterior Lights

The exterior lights are located on the corners of the cabinet panels. They provide a colorful luminance around the spa. These lights are activated from the light menu. The only light color option is white. At start-up, the exterior lights flash on and off to indicate a connection. The lights have a timeout period of 8 hours, except for the AUTO setting. For operating instructions refer to page 26.

11.14 Optional SmartTub® System

Advances in technology have allowed us to create a better and smarter hot tub. Our SmartTub® system operates on a cellular network. The advantages of this system are:

- A more stable connection to internet for outdoor environment. The SmartTub® device uses much less data than a typical voice connection via cellular networks. We contract through the largest wireless carriers to ensure maximum uptime. The system enables firmware updates via the cell connection so your system's performance will continuously be optimized remotely.
- Maintenance is made easy by alerts sent to your phone.
- Diagnostic alerts are sent to you and your dealer when attention is required.

A. Pairing process

1. Download the SmartTub® app from the Google Play store or Apple App store.
2. Open the app and create an account.
3. Locate the SmartTub® sticker next the control panel of the hot tub. You can either scan the QR code with the SmartTub® app or manually input the serial number located below the QR code on the sticker.
4. After you pair the hot tub's serial number to the SmartTub® app, the app will load and connect the hot tub to the internet.
5. Follow the instructions on the app to begin enjoying the benefits of your internet connected hot tub.

Note: The first year of data service is included. You will need to renew the subscription after the first year. Please refer to the terms of service and privacy policy links in the SmartTub® app for additional information.

J-LX Export

B. Indicator Lights

There are indicator lights on the SmartTub® controller that relay the status of the system. Below are meanings of the lights.

1. Cloud:
 - Blue light on - connected to cloud.
 - Blue light off - not connected to cloud.
2. Spa:
 - Blue light on - connected to spa controller
 - Blue light off - not connected to spa controller
3. Status:
 - Cyan light - breathing (slow pulsing) indicates the status is good.
 - Cyan light - flashing indicates that the system is completing a connection to the cloud.
 - Green light - flashing indicates waiting for a connection to the cellular tower.
 - Dark blue light - flashing indicates a SIM error.
4. Cell signal strength:
 - 3 blue LED lights indicates cell signal strength.

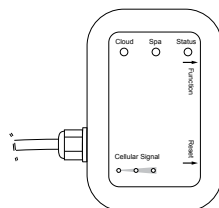

C. Resetting the SmartTub® controller

Should the SmartTub® controller need to be reset, you will need to hold a magnet to the reset label on the side of the SmartTub® device.

12.0 Programming and Operation Instructions

Your Jacuzzi spa is equipped with setting menus that allow you to program and activate different components of the spa. With our ProTouch control panel, programming your spa has never been easier. In the sections that follow, we will guide you through the process of programming the spa to fit your personal comfort. Tap  to enter the Settings Menu.

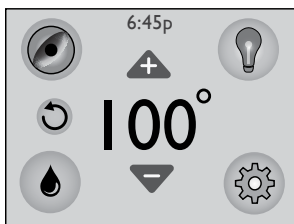

Figure 12.0a

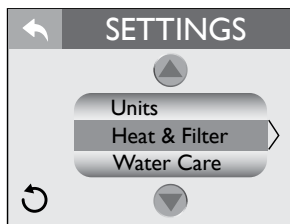





Figure 12.0b

Heat & Filter = **Heat and Filter:** Provides access to the heating and filtration programming, page 31.

Water Care = **Water Care:** Provides access to the water care programming, page 34.

- WiFi = **Wi-Fi:** Provides access to the Wi-Fi programming, page 37. Not applicable if the optional SmartTub® system is installed.
- Lock = **Lock:** Provides access to the spa lock programming, page 37.
- Time & Date = **Time and Date:** Provides access to the time and date programming, page 39.
- Language = **Language:** Provides access to the language programming, page 39.
- Units = **Units:** Provides access for the temperature display in **F°** or **C°**, page 40. Default setting is **F°**.
-  = **Back Button:** Tap to go back to the previous menu.
-  = **Invert Button:** Tap to invert the display image.
-  = **Scroll Buttons:** Scroll up and down to view the selections available.
- 

12.1 Programming the Heating Mode

Your Jacuzzi spa is equipped with 3 modes of heating, Figure 12.1a. An automatic mode called “Auto,” where the spa’s temperature is maintained at all times. An energy saving heating cycle called “Econo.” A mode that will only activate the heater during the daytime called “Day” mode.

Note: The heater will activate when the temperature drops 1°C (2°F) from the set temperature.

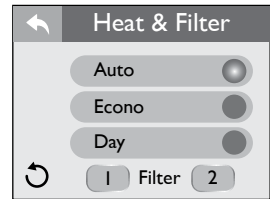







Figure 12.1a

 Indicates that the feature is active.  Indicates that the feature is not active.

From the Settings Menu, tap  or  to highlight the “Heat & Filter” menu tab in Orange. Tap  to enter the menu. Then select one of the heating settings.

A. Auto heating:

1. When programmed to “Auto,” the spa will maintain the water temperature to the set temperature. Heating will occur when necessary.
2. To select this mode, tap  next to the “Auto” icon.

J-LX Export

B. Econo heating:

1. This is an energy saving heating program that allows the spa to heat during non-peak hours. When programmed to “Econo,” the spa will only be allowed to heat the water between 5:00 PM to 7:00 AM every day of the week. The hours cannot be adjusted.
2. To select this mode, tap ● next to the “Econo” icon.

C. Day heating:

1. When programmed to “Day,” the spa will only be allowed to heat the water between 7:00 AM to 5:00 PM every day of the week. The hours cannot be adjusted.
2. To select this mode, tap ● next to the “Day” icon.

12.2 Programming the Primary Filter

To access the “Primary Filter” feature, tap 1 from the Heat & Filter menu, Figure 12.2a, to enter the “Primary Filter” programming menu, Figure 12.2b.

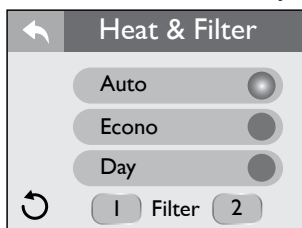

Figure 12.2a

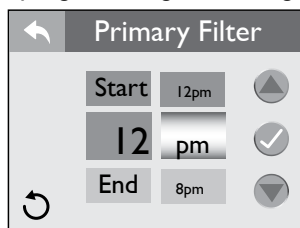

Figure 12.2b

During a primary filtration, the circulation pump, the ClearRay Active Oxygen® system are activated. The factory default cycle starts at 12:00 AM and last for 8 hours. If you elect to keep this setting, then you can skip this section.



In extreme bitter cold weather we recommend you program the circulation pump to run 24 hours. Refer to the “Winterizing” section on page 48.

Any time the circulation pump runs outside of a program cycle, e.g. for heating, that run time will be deducted from the next primary filter cycle. For example, the primary filter cycle is set to 8 hours every 24 hours but the circulation pump comes on for 2 hours to heat the water after the cycle has finished. The next primary filter cycle will only be for 6 hours not 8 hours.

A. To change the default cycle:

When you enter the menu, “Start” and “12” will be highlighted.

1. Tap ▲ or ▼ to change the hour in 1-hour increments. To switch from “AM” to “PM” you must round a 12-Hour period.
2. Tap ✓ to accept the change.
3. Tap End to program the end time for the cycle.

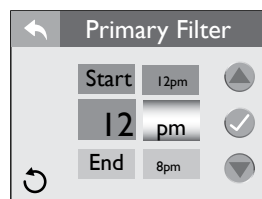







Figure 12.2c

4. Tap the hour block to change the end time.
5. Tap  or  to change the hour in 1-hour increments. To switch from “AM” to “PM” you must round a 12-Hour period.
6. Tap  to confirm and save your changes.
7. Tap , a couple of times, to return to the Heat & Filter Menu and the Settings Menu.

Summer Logic: In warm weather, the water temperature in the spa may exceed the set temperature. This condition may occur due to heat transference from the filter/circulation pump and jets pumps. If the water temperature is higher than 35°C (95°F) and rises 1°C (2°F) above the set temperature, a “Summer Logic” condition occurs that deactivates the filter/circulation pump, ClearRay Active Oxygen® System, and Secondary Filter cycle. This safety feature cannot be altered! The filter/circulation pump, ClearRay Active Oxygen® System, and Secondary Filter cycle will remain off until the water temperature cools to the set temperature (except when the filter/circulation pump runs for it’s mandatory 3-hour cycles between 8am-11am and 8pm-11pm.) To help prevent a “Summer Logic” condition, it may be necessary to reduce filter/circulation pump cycles run times in warm weather.

12.3 Programming the Secondary Filter

To access the “Secondary Filter” feature, tap  from the Heat & Filter Menu, Figure 12.3a, to enter the “Secondary Filter” programming, Figure 12.3b.

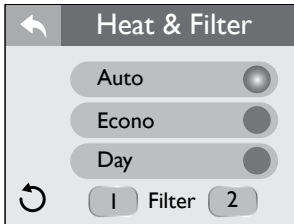

Figure 12.3a

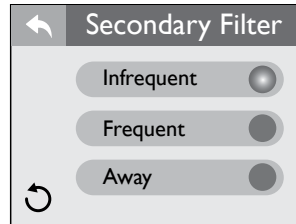





Figure 12.3b

During a secondary filtration, the Jets Pump 1 is activated. There are 3 cycles you can select from, Figure 12.3b. The factory default cycle is “Away Mode.” If you elect to keep this setting, then you can skip this section.

 Indicates that the feature is active.  Indicates that the feature is not active.

A. To change the Secondary Filter cycle:

1. Away Mode: Secondary Filtration is disabled. To activate this mode, tap  next “Away.” This is the factory default setting.
2. Infrequent Mode: Activates two cycles at 8:00 PM and 8:00 AM **every other day**. Each cycle will last 10 minutes for a total of 20 minutes every other day. To activate this mode, tap  next to “Infrequent.” Time and duration cannot be altered.

J-LX Export

3. Frequent Mode: Activates two cycles at 8:00 PM and 8:00 AM **every day**. Each cycle will last 10 minutes for a total of 20 minutes every day. To activate this mode, tap ● next to “Frequent.” Time and duration cannot be altered.
4. Tap ↶ to return to the Heat & Filter Menu. Tap again to return to the Settings Menu.

12.4 Cleanup Cycle

The cleanup cycle occurs once per day at 12:00 pm (noon) for 2 minutes. This is not user programmable. The Jets Pump 1 and the Circulation Pump will turn on for one minute and then shut off. Then Jets Pump 2 will turn on and run for 1 minute then shut off. The feature can be deactivated by turning off the corresponding jets pump that is running.

12.5 Blow-Out Cycle

This cycle will purge the air from the plumbing lines normally caused by draining and filling the spa. The Jets Pump 1 and the Circulation Pump will turn on for 1 minute and then shut off. Then Jets Pump 2 will turn on and run for 1 minute then shut off. The feature can be deactivated by turning off the corresponding jets pump that is running. This cycle will **only** occur at start up and after exiting a service lock.

12.6 Water Care Programming

Water care is crucial to maintaining a clean spa. The ClearRay system leads the way to a clean* spa by using a UV light bulb and ozone. Your spa can be programmed to remind you when to check and replace certain components.

From the Settings Menu, tap ▲ or ▼ to highlight the “Water Care” menu tab in Orange, Figures 12.6a and 12.6b. Tap Water Care to enter the menu. Then select one of the features.

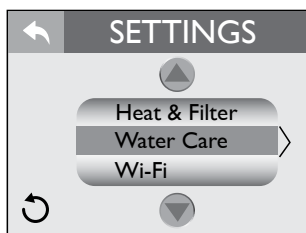

Figure 12.6a

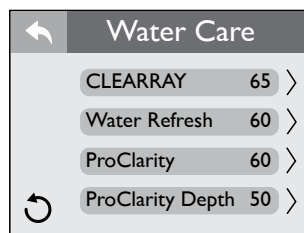

Figure 12.6b

*Clean is defined as the removal of microscopic (to 30 µm level) debris from the water. Ozone aids in the grouping of small debris. Once combined, the debris can be more easily caught by the filtration process.

A. Programming the ClearRay UV Bulb Timer

The ClearRay UV bulb has a life expectancy of 1 year. A timer activates when power is applied and begins a countdown starting at 365 days. Once the timer expires, an error message will appear of the display, the UV bulb must be replaced and the timer needs to be reset. Tap **CLEARRAY 65** > (Figure 12.6b) to enter the Programming Menu.



Figure 12.6c

Note: The days are stored in memory if the power is interrupted.

1. From the “Water Care” Menu you can to set the ClearRay® UV bulb timer, Figure 12.6c.
2. Tap or to change the days in 10-day increments. The range is from OFF to 365 days. The ClearRay® UV timer counts down by days not usage.

Note: It is not recommended that this feature be turned OFF. In order to continually have the ClearRay® system effectively preform its function, it should be program as instructed.

3. Tap to confirm and save your changes.
4. Tap to return to the “Water Care” Menu. Tap again to return to the Settings Menu.
5. When the timer expires, a message will appear on the control panel display, page 57. The ClearRay® UV bulb **must be replaced** (page 52) and the timer must be reset. Tap “reset” and follow the instructions above to reset the timer. If you tap “snooze” the message will clear but the error icon will display and the reminder screen will reappear in 10 days.

B. Programming the Water Change Timer

A programmable “Water Refresh” reminder can be set to remind you when to drain and refill the spa. Tap **Water Refresh 60** > (Figure 12.6b) to enter the Programming Menu.

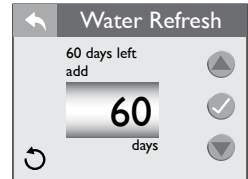

Figure 12.6d

1. From the “Water Care” Menu you can to set the “Water Refresh” timer, Figure 12.6d.
2. Tap or to change the days in 30-day increments. The range is from OFF to 180 days.

Note: It is not recommended that this feature be turned OFF. In order to continually maintain the water healthy and clean, in addition to chemical maintenance, it should be program as instructed.

3. Tap to confirm and save your changes.
4. Tap to return to the “Water Care” Menu. Tap again to return to the Settings Menu.
5. When the timer expires, a message will appear on the control panel display, page 58. The water must be drained and replaced with fresh water. Follow the instructions above to reset the timer. If you tap “snooze” the message will clear but the error icon will display and the reminder screen will reappear in 10 days. Refer to Section 13.1, page 41, for filter location.

J-LX Export

C. Programming the ProClarity Filter Timer

A programmable filter timer can be set to remind you when to clean or replace the filters and skimmer bag. Tap **ProClarity 60** > (Figure 12.6b) to enter the Programming Menu.

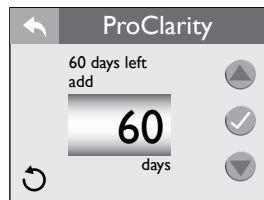







Figure 12.6e

1. From the “Water Care” Menu you can to set the “ProClarity” timer, Figure 12.6e.
2. Tap  or  to change the days in 10-day increments. The range is from OFF to 180 days.

Note: It is not recommended that this feature be turned OFF. In order to continually maintain clean and working filters, it should be program as instructed.

3. Tap  to confirm and save your changes.
4. Tap  to return to the “Water Care” Menu. Tap again to return to the Settings Menu.
5. When the timer expires, a message will appear on the control panel display, page 58. The filters must be cleaned or replaced. Follow the instructions above to reset the timer. If you tap “snooze” the message will clear but the error icon  will display and the reminder screen will reappear in 10 days. Refer to Section 13.1, page 41, for cleaning instructions.

D. Programming the ProClarity Depth Filter Timer

A programmable filter timer can be set to remind you when to replace the ProClarity Depth Filter. Tap **ProClarity Depth 50** > (Figure 12.6b) to enter the Programming Menu.

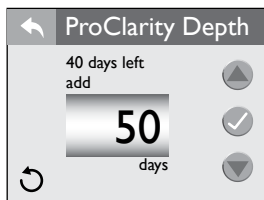







Figure 12.6f

1. From the “Water Care” Menu you can to set the “ProClarity Depth” timer, Figure 12.6f.
2. Tap  or  to change the days in 10-day increments. The range is from OFF to 90 days.

Note: It is not recommended that this feature be turned OFF. In order to continually maintain clean and working filters, it should be program as instructed.

3. Tap  to confirm and save your changes.
4. Tap  to return to the “Water Care” Menu. Tap again to return to the Settings Menu.
5. When the timer expires, a message will appear on the control panel display, page 58. Follow the previous instructions to reset the timer. The filter must be replaced. Refer to Section 13.1, page 41, for filter location. If you tap “snooze” the message will clear but the error icon  will display and the reminder screen will reappear in 10 days.

12.7 Optional Wi-Fi Setup (not applicable if the optional SmartTub® system is installed)

From the Settings Menu, tap ▲ or ▼ to highlight the “Wi-Fi” Menu tab in Orange. Tap **Wi-Fi** to enter the programming options, Figures 12.7a and 12.7b. Make sure you have downloaded the Wi-Fi App for this setup.

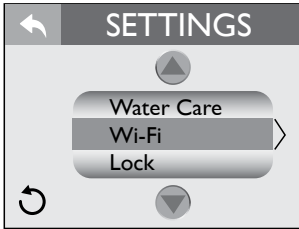

Figure 12.7a



Figure 12.7b

1. You need to follow the instructions from the App in order to connect the Wi-Fi.
2. While the system attempts to connect you will see the, “Spa Wi-Fi Setup in-progress,” Figure 12.7b. When the connection is done the display will read, “Spa Wi-Fi Setup Successfully Connected.”

If the Wi-Fi connection setting should need to be updated or connected to a new router, follow the steps below.

1. From the “Settings” menu, tap **Wi-Fi** (Figure 12.7a) to enter the menu.
2. Tap **Reset?**. The display will change to “Spa Wi-Fi Setup In-progress” and the reset button will be highlighted in Orange.
3. Tap **Reset?** again. This will clear the current data and allow the spa to connect to the new data.
4. Reconfigure and setup your spa by following the instructions from the app.

12.8 Locking the Spa

From the Settings Menu, tap ▲ or ▼ to highlight the “Lock” menu tab in Orange. Tap **Lock** (Figure 12.8a) to enter the programming options, Figures 12.8a and 12.8b. You can prevent users from changing certain features of the spa. When a lock feature is active, the lock icon  will appear on the Main Menu. When you enter the “Lock” Menu, if one of the three settings is locked, it will be highlighted Orange.

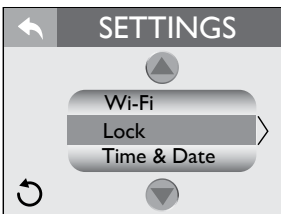

Figure 12.8a

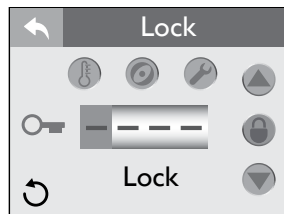













Figure 12.8b

J-LX Export





A. Temp Lock (Figure 12.8b):

1. Tap  to lock the temperature feature.
2. Tap  (the first block) to select a number. Use  or  to select a number from 0-9. Then move on to the next number until a four-digit code has been selected.
3. Tap  to activate the locking feature.
4. The adjust temperature feature is disabled, but the spa will still perform all scheduled tasks.
5. Tap  to return to the “Settings” Menu.

B. Spa Lock (Figure 12.8b):



1. Tap  to lock the spa. When this feature is activated both the spa and temperature lock are highlighted Orange.
2. Tap  (the first block) to select a number. Use  or  to select a number from 0-9. Then move on to the next number until a four-digit code has been selected.
3. Tap  to activate the locking feature.
4. All activation and adjustment features are disabled but the spa will still perform all scheduled tasks.
5. Tap  to return to the “Settings” Menu.

C. Service Lock (Figure 12.8b):

1. Tap  to lock the spa. When this feature is activated all the lock buttons highlighted Orange.
2. Tap  (block) to select a number. Use  or  to select a number from 0-9. Then move on to the next number until a four-digit code has been selected.
3. Tap  to activate the locking feature.
4. All spa functions are locked to allow for a temporary service mode for filter cleaning.

Note: This mode has a time out of 2 hours. The spa should not be left in this lock mode for an extended period. Especially in colder climate or when freezing conditions exist.

D. To Unlock (Figure 12.8c):

1. Enter the Lock menu. The type of lock that is active will already be highlighted in Orange.
2. Tap  (the first block) to start entering the code. Then move on to the next number until the four-digit unlock code has been entered.
3. Tap  to unlock.
4. Tap  a few times to exit the menu.

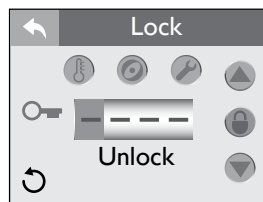

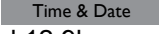

Figure 12.8c

Note: A default passcode can be used in case the original passcode is lost or forgotten. The code “0772” will unlock the locked setting.

12.9 Programming the Time and Date

From the Settings Menu, tap  or  to highlight the “Time & Date” menu tab in Orange. Tap  to enter the programming options, Figures 12.9a and 12.9b.

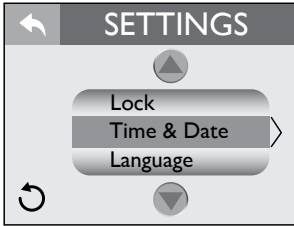











Figure 12.9a



Figure 12.9b

A. To set the time:

The default time setting is a 12-Hour configuration. To choose the 24-Hour configuration, then tap  to change the setting.

1. When you enter the menu,  will be highlighted Orange, Figure 12.9c.
2. Tap the hour block  to program.
3. Tap  or  to change the hour in 1-hour increments. To switch from “AM” to “PM” you must round a 12-Hour period.
4. Tap the minute block  to program.
5. Tap  or  to change the minutes.
6. Tap  to confirm and save your changes.

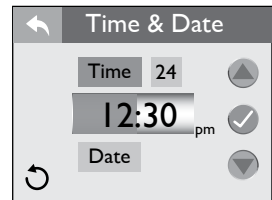













Figure 12.9c

B. To set the date:

Each setting for month, day and year can be set independently.

1. Tap  to program the date, Figure 12.9d.
2. Tap the month block  to program.
3. Tap  or  to make changes.
4. Tap the day block  to program.
5. Tap  or  to make changes.
6. Tap the year block  to program.
7. Tap  or  to make changes.
8. Tap  to save and accept the changes.
9. Tap  to return to the “Settings” Menu.

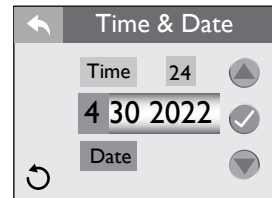

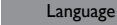

Figure 12.9d

J-LX Export

12.10 Programming the Language

From the Settings Menu, tap  or  to highlight the “Language” menu tab in Orange. Tap  to enter the language options, Figures 12.10a and 12.10b.

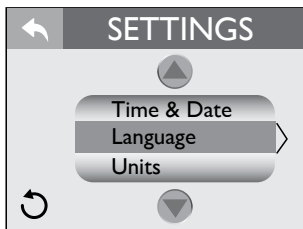

Figure 12.10a

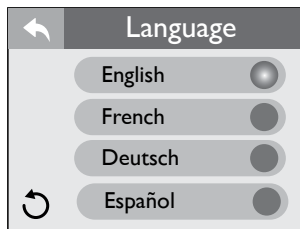









Figure 12.10b

1. There are 4 languages to select from: English, French, Deutsch, and Español. To select a language, tap  next to the language you want to display, Figure 12.10b.
2. Tap  to return to the “Settings” Menu.

12.11 Units Display

From the Settings Menu, tap  or  to highlight the “Units” Menu tab in Orange. Tap  to enter the selection menu, Figures 12.11a and 12.11b.

1. Tap  next to the unit of measure that you want to display.
2. Tap  a few times to return to the Main Menu.

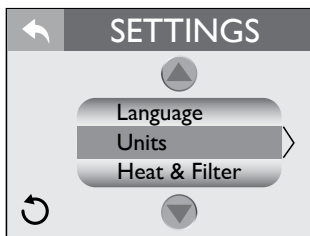

Figure 12.11a

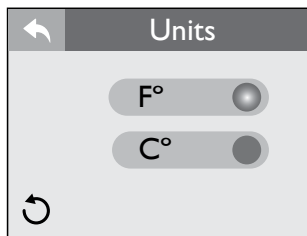

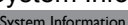
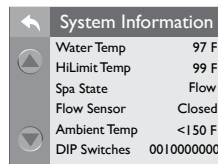

Figure 12.11b

12.12 System Information

This menu will display the current information for the spa. From the Settings Menu, tap  or  to highlight the “System Information” Menu tab in Orange. Tap  to enter the selection menu, Figure 12.12a. There are no selections that can be made. The menu simply provides information.

A screenshot of the 'System Information' screen. At the top is a back arrow and the title 'System Information'. Below are six rows of information, each with a small up/down arrow icon on the left: 'Water Temp 97 F', 'HiLimitTemp 99 F', 'Spa State Flow', 'Flow Sensor Closed', 'Ambient Temp <150 F', and 'DIP Switches 001000000'.

Water Temp	97 F
HiLimitTemp	99 F
Spa State	Flow
Flow Sensor	Closed
Ambient Temp	<150 F
DIP Switches	001000000

Figure 12.12a

13.0 Spa Maintenance

Proper and regular maintenance of your spa will help it retain its beauty and performance. Your authorized Jacuzzi dealer can supply you with all the information, supplies, and accessory products you will need to accomplish this.



DANGER: RISK OF SEVERE INJURY OR DROWNING BY ENTRAPMENT!

- Keep hair, loose articles of clothing or hanging jewelry away from suction fittings, rotating jets or other moving components to avoid entrapment that could lead to drowning or severe injury.
- Never use the spa unless all suction guards, filter, filter lid, or skimmer assembly are installed to prevent body and/or hair entrapment.
- Never operate or use the spa if the filter, filter lid, or skimmer assembly are broken or any part of the skimmer assembly is missing. Please contact your dealer or nearest service center for service.
- The suction fittings and suction covers in this spa are sized to match the specific water flow created by the pump(s). If it is necessary to replace the suction fittings, suction covers or pump(s), be sure that the flow rates are compatible and are in compliance with the VGB Safety Act, page 2.
- Never replace a suction fitting or suction cover with one rated less than the flow rate marked on the original suction fitting. Using improper suction fittings or suction covers can create a body or hair suction entrapment hazard that may lead to drowning or severe injury.
- Owners must alert all spa users to the potential risk of Hair, Limb, Body, Evisceration (disembowelment), and Mechanical Entrapment, page 6.

13.1 Cleaning The Filters

A reminder message appears on the control panel display after a specified number days to remind you to clean the skimmer filter and to check the polishing bag filter. This reminder must be reset at each filter cleaning interval. Refer to Section 12.6 (page 34) for additional

information and programming details. Your new spa is equipped with an advanced 2-Stage filtration system. Fine debris are filtered by the circulation pump drawing water through the ProClarity™/ProClear™ skimmer and pleated filter cartridges. Large debris are filtered when jets pump 1 is running when the spa is in use or during a programmed filter cycle. These pumps draw water from footwell suction fitting and through a secondary water polishing bag filter and additional filter.



Reminder

It's time to clean or replace your ProClarity and ProClear filters. Contact your authorized dealer if new filters are needed.

reset

snooze

J-LX Export

A. Cleaning the filters and filter bag

To ensure optimum performance:

1. The ProClarity™ filter cartridge (A) must be cleaned every month and replaced every 18 months.
2. The ProClarity Depth filter (B) must be replaced every 3 months.
3. The ProClarity filter canister (C) can be rinsed when the filters are cleaned.
4. The ProClear II skimming filter cartridge (D) must be cleaned every month and replaced every 18 months.
5. The ProClarity debris bag (E) should be checked and emptied monthly.

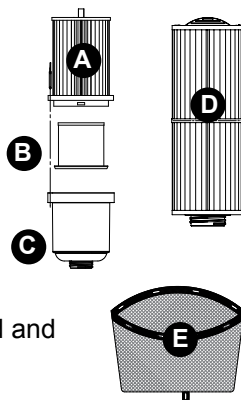

To accomplish this, refer to the following filter cleaning procedure. The primary filter cartridge goes on the side that is closest to the front of the spa.

Note: Do not attempt to wash the ProClarity depth filter (B) and the ProClear/ProClarity debris bag (E) or it will come apart!

B. Cleaning the Filters/Debris bag

- A** **DANGER: TURN POWER TO SPA OFF! TO DECREASE RISK OF DEATH, DROWNING, OR ENTRAPMENT, NEVER OPERATE SPA WHEN FILTER IS NOT PROPERLY INSTALLED OR IF SKIMMER ASSEMBLY IS DAMAGED OR ALTERED!** ⚠

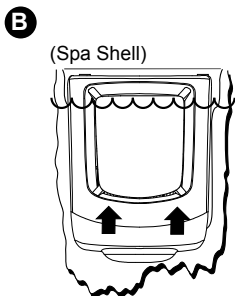

Lift upward on filter cover to release it from the mating retaining clips. Then tilt forward to remove and access filter cartridges.



Remove skimmer bag from clips, then clean out debris.

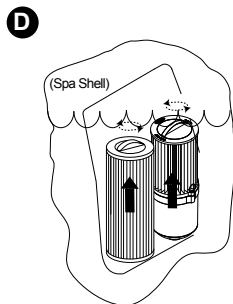

Rotate each filter cartridge handle counterclockwise to unthread from mating wall fitting.

E

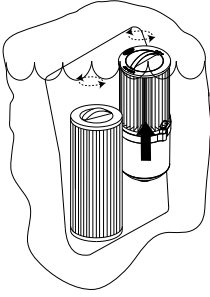

Lift unthreaded filter cartridge from skimmer well.

Note: Primary filter fitting is the one with the grid.

F

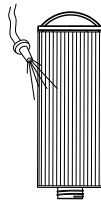

Cartridge 1

If used, remove the chemical feeder as instructed prior to rinsing the filter cartridge. Rinse debris from filter pleats using a garden hose and high-pressure nozzle. Start at the top and work downward towards handle. Repeat until all pleats are clean.

G

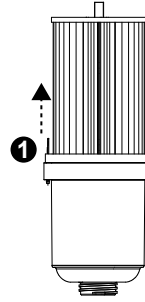

Remove the filter pin **1** in order to separate the ProClarity filter and canister.

H

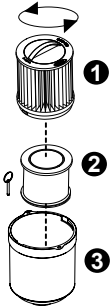

Once the filter pin is removed, rotate the filter cartridge handle counterclockwise to unthread from the filter canister. You can clean the filter **1** and canister **3**, but you must replace the ProClarity Depth Filter **2** every 3 months.

I

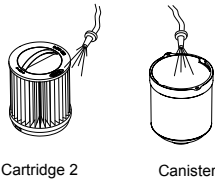

Rinse debris from filter pleats using a garden hose and high-pressure nozzle. Start at the top and work downward towards handle. Repeat until all pleats are clean. Rinse out any debris from the canister.

J

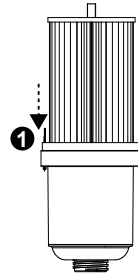

Reassemble the ProClarity Filter. Remember to replace the depth filter with a new one. Once the filter is assembled, secure it with the filter pin **1**.

J-LX Export

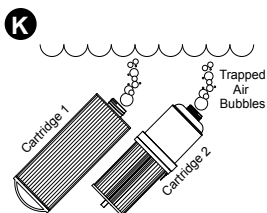

Submerge both filter cartridges in spa. Tilt threaded end upward to remove trapped air bubbles, then keep cartridges submerged to prevent air entrapment during installation.

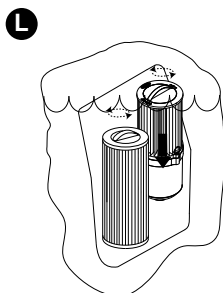

Place each cartridge back into skimmer well, then rotated each cartridge handle clockwise to thread back into wall fitting. **DO NOT OVERTIGHTEN!**



(Filter Cover Back View)

Install clean debris bag back onto the filter cover back onto the filter cover clips as shown (you can flip the filter skimmer and use the back side to extend usage).

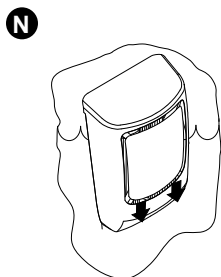

Reinstall the skimmer shield over the filters. Then turn power to spa back on.

Periodically, the filter cartridge will need a more thorough cleaning to remove imbedded oils and minerals. For this, we suggest cleaning as illustrated followed by soaking the filter overnight in a plastic container filled with a solution of water and specially formulated filter cleanser available from your authorized Jacuzzi dealer. The average life expectancy of each filter is approximately two years with proper care and water quality maintenance. Replacement cartridges may be purchased from your authorized Jacuzzi dealer.

13.2 Draining and Refilling

About every 3 months, you will want to replace the spa's water. The frequency depends on a number of variables including the amount of use, attention paid to water quality maintenance, etc. You will know it is time for a change when you cannot control sudsing and/or you can no longer get the normal feel or sparkle to the water even though the key water balance measurements are all within the proper parameters.

CAUTION! READ THIS BEFORE DRAINING: To prevent damage to the spa's components, **turn off power to the spa at the circuit breaker before draining it.** Do not turn the power back on until your spa has been refilled.

CAUTION: There are certain precautions to keep in mind when draining your spa. If it is extremely cold, and the spa is outdoors, freezing could occur in the lines or the equipment, see "WINTERIZING" (page 48). On the other hand, if it is hot outdoors, do not leave the spa's surface exposed to direct sunlight.

To drain your spa, perform the following steps:

1. Turn off power to spa at breaker.
2. Locate the drain valve on the front/lower plastic pan. Hold the larger (rear) body to prevent it from turning, then loosen and remove the front cap to expose the underlying male hose threads.
3. Attach a garden hose to the exposed threads.
4. Gently rotate the larger (rear) valve body 1/3 turn counterclockwise to unlock the drain valve.
5. Pull the larger (rear) body outward to open drain.
6. After the spa drains, perform steps 2-5 in reverse order to close the drain prior to refilling the spa. If an airlock occurs, see troubleshooting section page 59.

1. Turn off power to spa.

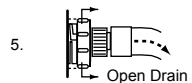
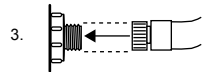
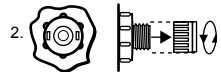

After refilling, turn on power to the spa and follow the steps listed under "Spa Fill Up Procedure" (page 17). Always fill your spa through both filter wall fittings.

J-LX Export

13.3 Pillow Care

Remove and clean the headrest pillows as needed with soapy water using a cloth or soft-bristle brush. Always remove the pillows when adding chemical shock treatment to the spa water. The pillows can be returned to the spa when the sanitizer reading is stable as recommended on the inside cover of the manual.

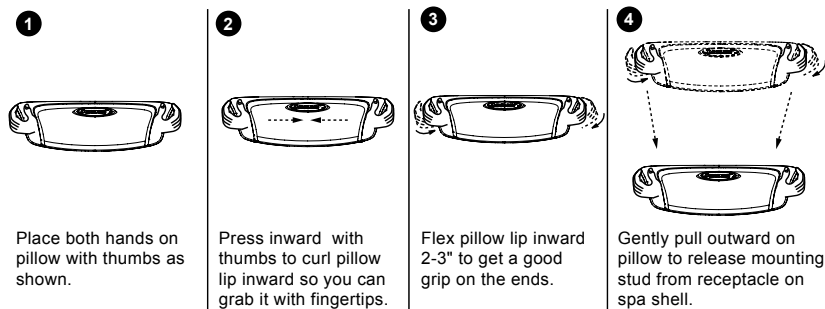

- 5** Wash pillow(s) in a mild detergent soap and warm water solution. Never machine wash your pillows or attempt to clean them with a non-approved vinyl cleaning agent!
- 6** To reinstall pillows: Simply align pillow over mounting stud receptacle, then gently push inward to snap in place.

13.4 Cleaning The Spa Interior

To preserve the sheen of your spa's surface, it is crucial that you avoid using abrasive cleaners or cleaners which have adverse chemical effect on the surface. If you are not certain as to the suitability of a particular cleanser, consult your authorized Jacuzzi dealer. Regardless of the cleanser used, use extreme care to assure that no soap residue is left on the surface. This could cause severe sudsing when the spa is refilled.

13.5 Maintaining the Cover

Covers distributed by Jacuzzi Hot Tubs have PROLAST™/PROLAST™ Extreme encasement. The PROLAST™/PROLAST™ Extreme encasement also referred to as the cover "skin" is attractive and durable. Regular monthly cleaning is strongly recommended and may increase the longevity of your cover. Jacuzzi chemicals are for use in the U.S. only.

Note: It is highly recommended that you DO NOT put the seam over the control panel. This will cause premature failure of the control system.

A. To clean cover skin:

1. Use a garden hose to remove any debris.
2. Using a large sponge or soft bristle brush, use diluted or mild soap to gently scrub the top.
3. Rinse and clean and do not allow soap to dry on the cover. Do not use soap on the underside of the cover.
4. Do not use any solvents, abrasive cleaners or strong detergents. Do not use products that contain silicone or alcohol.

B. Additional Care and Maintenance Instructions:

1. Debris can accumulate on the spa cover. Removal of snow or other debris will help to avoid breakage of the foam cores.
2. Be sure to lock the cover straps to secure the cover from unwanted or accidental entry.
3. Do not place heavy objects on the cover.
4. Do not walk, sit or stand on the cover.
5. Do not drag or use the flaps/skirt or the cover lock straps to remove the cover.
6. Use only recommended cover lift systems.
7. Use only chemicals and cleaners recommended by Jacuzzi.
8. Remember to keep spa covered when not in use. Maintaining proper water levels assures efficient operation and efficient electrical usage.
9. Do not expose your spa to the sun for extended periods of time as UV rays can damage the interior surface.
10. Use caution when removing cover. Before removing cover, assure all locks have been released to avoid lock breakage and or cover strap damage.

13.6 Maintaining The Synthetic Cabinet

Your new spa's synthetic cabinet requires little or no maintenance of any kind. To clean, simply wipe cabinet with a clean towel and mild soap solution.

13.7 Top Rail Care And Maintenance

To preserve the luster of the surfaces of your spa, it is essential not to use abrasive cleaners or chemical cleaners that can attack the surface. If you are unsure whether any product is suitable for your spa surfaces, consult your authorized Jacuzzi dealer. We recommend using Jacuzzi Spa All Purpose Cleaner to clean the interior surface of the spa. Make sure that there is no residue of any product used that is not rinsed from the surfaces of the spa. This could cause extreme foaming of the spa water.

13.8 Stainless Steel Corners

To prolong the life of the corner trim, handle it with care and clean it regularly. Below are the care instructions.

1. A simple solution of warm water with a couple of drops of liquid soap makes an excellent cleaner.
2. Dampen a soft cloth (such as a microfiber cloth) into the cleaning solution.
3. Wipe and clean the outer faces moving along the length of the part.
4. Dry off the corner trim using another clean, dry soft cloth.

Note: Never use abrasive cleaners, steel wool, scrubbing brushes, or scrubbing pads on the corner trim.



CAUTION: Never spray cabinet with a garden hose for any reason since this action may induce an electrical short in the spa's electrical equipment.

J-LX Export

13.9 Winterizing

Your Jacuzzi spa is designed to automatically protect itself against freezing when operating properly. During periods of severe freezing temperatures, you should check periodically to be certain that the electrical supply to the spa has not been interrupted. In extreme, bitter cold weather less than 0°C (32°F), choose the Programming The Primary Filter Cycle and auto-heating is selected (Auto-Heating, page 31) to protect against damage to the spa.

If you do not intend to use your spa, or if there is a prolonged power outage during periods of severe freezing temperatures, **it is important that all water be removed from the spa and equipment to protect against damage from freezing.**

Expert winterization of your spa is highly recommended, contact your authorized Jacuzzi dealer. In emergency situations, damage can be **minimized** by taking the following steps:

CAUTION: TURN OFF POWER TO HOT TUB!

1. Turn off power to the spa.
2. Follow the directions on page 45 for draining the spa.
3. Turn the massage/diverter selector(s) into the middle combo position to allow the water in the plumbing lines to drain, page 28.
4. Turn the waterfall valve(s) to the open position to allow the water in the plumbing lines to drain, page 28.
5. Open all the air controls and leave them open until you resume use of the spa, page 28.
6. As the water level drops below the seats, use whatever means necessary to get the water out of the recessed seating areas and into the foot well, such as a wet/dry vacuum.
7. When the water level ceases to drop, use whatever means available to remove any remaining water from the foot well, such as a wet/dry vacuum.
8. Remove the synthetic cabinet panel under the control panel and locate the drain plugs on the front of the pump(s), (Figure B, page 14). Remove plugs to allow water to drain out of pumps and heater.
Note: Approximately one to two gallons will be released during this procedure. Use a wet/dry vacuum or other means to keep this from flooding the equipment compartment. Replace the drain plugs.
9. Loosen the hose clamp on the circulation pump intake behind the control box (Figure B, page 14) and pull the hose off (twist hose back and forth while pulling outward). Tip hose down and allow to drain, then reinstall hose and clamp.
10. Loosen hose clamp at bottom of ClearRay® unit and pull hose off of fitting (twist the hose back and forth while pulling downward). Tip hose down and allow to drain. Then reinstall hose and clamp. Remove the cover of the ClearRay unit to access the UV bulb and quartz tube.

Remove and store the UV bulb in a safe location. Remove and dry off the quartz tube then reinstall it. Depending on the length of time, consider replacing the UV bulb when you resume use of your hot tub.

11. Reinstall synthetic cabinet side panel and cover spa so that no casual moisture can enter into it.

Consult your authorized Jacuzzi dealer if you have any questions regarding winter use or winterizing.

13.10 Restarting Your Spa in Cold Weather

If you want to start up your spa after it has sat empty for a time in freezing temperatures, be aware that the water remaining in certain sections of the piping may still be frozen. This situation will block water flow preventing the spa from operating properly and possibly damaging the equipment. We recommend you consult your authorized Jacuzzi dealer for guidance before attempting to restart your spa under these conditions.

14.0 Water Quality Maintenance

To decrease the risk of contracting a waterborne illness (e.g. an infection, bacteria or virus) and/or respiratory ailments, maintain water quality within specified limits. This will enhance your enjoyment and prolong the life of the hot tub's equipment. Doing so requires regular attention because the water chemistry involved is a balance of several factors. Procrastination in regard to water maintenance will result in poor and potentially unhealthful conditions for soaking and even damage to your hot tub investment. For specific guidance on maintaining water quality, consult your authorized Jacuzzi dealer who can recommend appropriate chemical products for sanitizing and maintaining your hot tub.



WARNING: FAILURE TO MAINTAIN WATER QUALITY WILL:

- Increase risk of contracting a waterborne illness (e.g. an infection bacteria or virus) and/or respiratory ailments.
- Damage the equipment, components and spa shell, which are not covered under the hot tub's warranty.

CAUTION: Never store hot tub chemicals inside the hot tub's equipment bay. The equipment bay may reach elevated temperatures, this is where high voltage electronic devices are located. This area is not intended for storage of any kind.

J-LX Export

14.1 pH Control

pH is a measure of relative acidity or alkalinity of water and is measured on a scale of 0 to 14. The midpoint of 7 is said to be neutral, above which is alkaline and below which is acidic. In spa water, it is very important to maintain a slightly alkaline condition of 7.4 to 7.6 pH. Problems become proportionately severe the further outside of this range the water gets. A low pH will be corrosive to metals in the spa equipment. A high pH will cause minerals to deposit on the interior surface (scaling). In addition, the ability of the sanitation agents to keep the spa clean is severely affected as the pH moves beyond the ideal range. That is why almost all spa water test kits contain a measure for pH as well as the sanitizer.

14.2 Sanitizing

To destroy bacteria and organic compounds in the spa water, a sanitizer must be used regularly. Chlorine and bromine are the two most popular sanitizers used to date. The "Proclear Mineral Spa Clarifier" designed especially for your hot tub is a beneficial product for water maintenance. Many other additives are available for your spa. Some are necessary to compensate for out-of-balance water; some aid in cosmetic water treatment and others simply alter the feel or smell of the water. Your authorized Jacuzzi dealer can advise you on the use of these additives. When adding spa shock (chlorine or non-chlorine) or pH balancing chemicals activate the jets pump(s) and leave the spa cover open for a minimum of 20 minutes. By doing this you will allow excessive chemical vapors to exit the spa, protecting pillows and plastic knobs from chemical attack.



WARNING: RISK OF PERSONAL INJURY, DROWNING OR ENTRAPMENT!

Never leave your hot tub unattended for any reason while the cover is open and accessible, especially to small children and animals!

CAUTION: RISK OF PERSONAL INJURY OR SPA DAMAGE!

Never add chlorine tablets (trichlor) or acid to your hot tub for any reason! These chemicals may damage components within your hot tub, burn or irritate your skin, create a rash and void the manufacturer warranty for your spa.

14.3 ClearRay Water Purification System

Your new hot tub has the ClearRay Active Oxygen® System installed. The ClearRay Active Oxygen® System is an exclusive technology utilizing ultraviolet light and ozone technology to help keep your water clean*. The ballast is the power supply for the ClearRay Active Oxygen® System; it has two LED indicator lights, the green indicating incoming power flow and the red indicating the system is properly working. ClearRay Active Oxygen® is standard for all models.

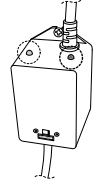

After a year the bulb must be replaced. A message will appear on the LCD display when the time allotted has expired. In order to clear the message, a new UV bulb needs to be installed and the timer must be reset (page 49).



WARNINGS:

- Do not operate the UV-C emitter when it is removed from the appliance enclosure.
- This appliance contains a UV-C emitter.
- Unintended use of the appliance or damage to the housing may result in the escape of dangerous UV-C radiation. UV-C radiation may, even in little doses, cause harm to the eyes and skin.
- Appliances that are obviously damaged must not be operated.
- Read the maintenance instructions before opening the appliance.

*Clean is defined as the removal of microscopic (to 30 µm level) debris from the water. Ozone aids in the grouping of small debris. Once combined, the debris can be more easily caught by the filtration process.

J-LX Export

14.4 ClearRay® UV Bulb Replacement and Quartz Tube Maintenance

Important: It is **MANDATORY** that the UV bulb is replaced and the quartz tube be cleaned every 12 months to maintain optimum performance.

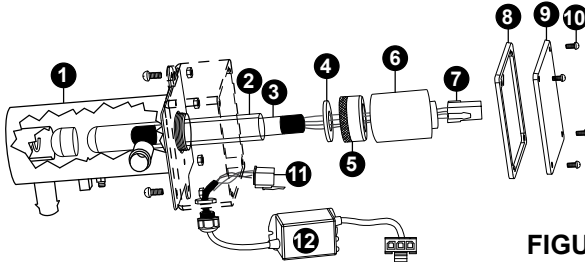

FIGURE 1



DANGER: TURN THE SPA BREAKER TO THE OFF POSITION!



DANGER: DRAIN THE SPA IF YOU ARE REPLACING OR CLEANING THE QUARTZ TUBE!



WARNING: ALLOW LAMP TO COOL DOWN PRIOR TO REMOVING FROM QUARTZ TUBE.



DANGER: NEVER LOOK AT THE LIT BULB. THIS CAN CAUSE SEVERE EYE DAMAGE OR BLINDNESS.

UV BULB REPLACEMENT AND QUARTZ TUBE MAINTENANCE:

Note: Location of ClearRay System and connection may vary by model.

1. Turn the breaker to the spa OFF. DRAIN YOUR SPA.

Note: If you are only replacing the UV bulb then the spa does not have to be drained. You will need to drain it if you are replacing or cleaning the quartz tube.

2. Once the UV bulb has cooled off remove the ClearRay unit enclosure cover (9) and gasket (8) by removing the four screws (10). This will expose the UV bulb and connections, Figure 2.

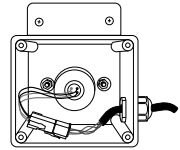

FIGURE 2



DANGER: NEVER REMOVE COVER WITHOUT FIRST TURNING OFF AT POWER SOURCE AND DRAINING THE SPA.

FIGURE 3

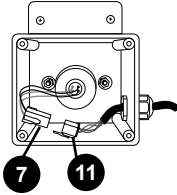

FIGURE 4

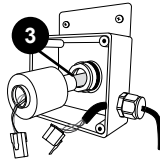

FIGURE 5

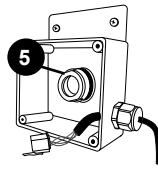
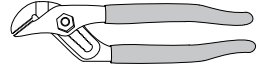
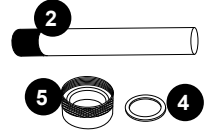

FIGURE 6



3. Disconnect UV bulb socket (7) from the power cord socket (11), Figure 3.
4. Slowly remove the UV bulb (3) out of the quartz tube, Figure 4.
5. Remove the quartz seal compression nut (5) by turning it **counterclockwise**, Figure 5. Use a pair of channel-lock pliers if needed, Figure 6. You will notice that there is a stainless steel compression washer (4) which slides over the quartz tube, save the washer (4) for later use, Figure 7.



6. Now you are ready to clean or replace the quartz tube (2). For cleaning the quartz tube (2), follow steps 7 and 8 then proceed from step 9. For replacing quartz tube (2), skip steps 7 and 8 and proceed from step 9.
7. **Cleaning quartz tube:** Clean the quartz tube by wiping, until clear, using a paper towel or a dry cotton cloth. If needed, a household tub and shower lime removal product can be used.



WARNING: Do not use abrasive cleaners as they can scratch the quartz tube surface.

8. Rinse the quartz tube with clean water to completely remove any cleaning products that were used in step 7.
9. **Replacing quartz tube:** You will notice that the new quartz tube does not have a black cushion on the domed end as the old quartz tube does. This is normal as the cushion was provided with the original quartz tube to protect it from breakage during transportation. Place the new quartz tube (2) into the water chamber (1) with the domed end first making sure it is inserted and seated inside the quartz end holder. Only a small portion will be exposed when it is seated correctly.
10. Reinstall the compression washer (4) over the open end of the quartz tube (2).
11. Reinstall and hand tighten the quartz seal compression nut (5) by turning it **clockwise**.
12. Refill your spa.
13. **System Test 1:** Assure there is no water dripping from the seal compression nut (5). If water is visible, STOP and tighten the compression nut (5) using a pair of channel lock pliers to a maximum of 1/4 turn. If that does not fix the leak, then repeat quartz tube maintenance process from step 1 through step 12. Make sure there is no water leaking before proceeding to step 14.

J-LX Export

14. **System Test 2:** Reconnect the ClearRay unit to the controller. Turn breaker back ON. Turn on the pump to circulate the water through the ClearRay System. Wait for 5 minutes and assure no water is dripping. If water is visible, STOP, fix the leak by repeating quartz tube maintenance process from step 1 through step 13. **Make sure there is no water visible. Turn the pump and breaker OFF BEFORE proceeding to step 15.**
15. Reconnect the UV bulb socket (7) to the power cord socket (11) make sure you use the latex glove provided when handling the UV bulb.



WARNING: DO NOT TOUCH THE NEW UV BULB WITH YOUR BARE HAND. Oil on your skin will cause hot spot on the UV bulb and shorten the life of your UV bulb. Use the provided latex glove to handle the UV bulb.

16. Slide the new UV bulb (3) back inside the quartz tube.
17. Reinstall the black bulb boot (6) back over the quartz seal compression nut (5).
18. Reinstall the enclosure cover (9) with gasket (8) and secure with the screws.
19. Properly dispose of the old UV bulb.



WARNING: This ClearRay System includes a UV bulb, which contains mercury. Dispose of the bulb in accordance with disposal laws. See www.lamprecycle.org.

20. Once power is activated you can check the ballast (12), Figure 8, to see if the ClearRay System is functioning; it has two LED indicator lights the green indicating incoming power flow and the red indicating the system is properly working.

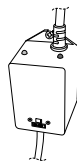



FIGURE 8

15.0 Error/Display Messages

There are a number of unique functions designed into your Jacuzzi spa to protect it from damage and/or to aid in troubleshooting. When this occurs the spa will notify you by showing the screen below, Figure 15.0a. Following is a listing of all the possible messages along with their meanings. **Always insist on genuine Jacuzzi replacement parts.** **Note:** If you tap  the display will change to Figure 15.0b. The error icon  will remain on the screen as a reminder. If the error is not taken care of or fixed, the error display will reappear in 2 hours, Figure 15.0a.

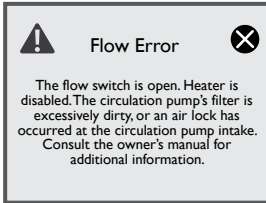

Figure 15.0a



Figure 15.0b

1. **Open Flow Switch:** (Heater is deactivated. The filter/circulation may also be deactivated.) The flow switch is open, the circulation pump's filter is excessively dirty or an air lock has occurred at the circulation pump intake. Consult the owner's manual for additional information.
2. **Closed Flow Switch:** (Heater is deactivated. The filter/circulation may also be deactivated.) The flow switch is malfunctioning closed. Contact your authorized dealer or service organization.
3. **Flow Restriction:** Heater is disabled, check for dirty filter. Consult the owner's manual for additional information.



Note: Make sure to clean the filter(s) and correct proper water level before contacting your dealer or service organization.

4. **Shorted Hi-limit Temp Sensor:** The hi-limit temperature sensor is not functional. Heater is disabled. This must be repaired only by a qualified authorized service organization or service technician.
5. **Open Hi-limit Temp Sensor:** The hi-limit temperature sensor is not functional. Heater is disabled. This must be repaired only by a qualified authorized service organization or service technician.
6. **Shorted Water Temp Sensor:** The temperature sensor is not functional. Heater is disabled. This must be repaired only by a qualified authorized service organization or service technician.
7. **Open Water Temp Sensor:** The temperature sensor is not functional. Heater is disabled. This must be repaired only by a qualified authorized service organization or service technician.

J-LX Export

8. Closed Flow Switch on Start-up: Flow switch is non-functional. Closed or shorted flow switch on system start-up (system disabled). Contact your authorized dealer or service organization.
9. Frozen on Start-up: Flow switch is non-functional. Shorted flow switch on system start-up (system disabled) and freeze condition detected. Contact your authorized dealer or service organization.
10. Cool Warning: Spa water is more than 11°C/20°F cooler than the temperature set point, the circulation pump and heater will automatically activate to provide freeze protection. The spa will stay in this mode until the water temperature reaches 8°C/15°F below the set temperature. No corrective action is necessary.
11. Freeze protection: A potential freeze condition has been detected. No action is required. Jets pump(s) operate until the spa is out of danger. No corrective action is necessary. If condition persists, contact your authorized dealer or service organization.
12. Overheat protection: **DO NOT ENTER THE WATER!** Spa water temperature is above acceptable limits. Heater is deactivated. Remove spa cover to speed cooling. Contact your authorized dealer or service organization.

Note:



- As a safety measure, the red lights of the spa will flash on and off as an indication that the spa is an overheat condition.
- The heater icon  will be blinking and the error icon  will be displayed under the temperature.



**WARNING: RISK OF HYPERTHERMIA (OVER-HEATING)
CAUSING SEVERE INJURY, BURNS, OR WELTS.**

13. Overheat protection: **DO NOT ENTER THE WATER!** Hi-limit temperature is above acceptable limits. Heater is deactivated. Remove spa cover to speed cooling. Contact your authorized dealer or service organization.



Note:

- As a safety measure, the red lights of the spa will flash on and off as an indication that the spa is an overheat condition.
- The heater icon  will be blinking and the error icon  will be displayed under the temperature.



**WARNING: RISK OF HYPERTHERMIA (OVER-HEATING)
CAUSING SEVERE INJURY, BURNS, OR WELTS.**



14. Watchdog Protection: **DO NOT ENTER SPA!** Spa water temperature is above acceptable limits. Your spa is deactivated. Remove spa cover to speed cooling. Contact your authorized dealer or service organization.

Note: The heater icon  will be blinking and the error icon  will be displayed under the temperature.



**WARNING: RISK OF HYPERTHERMIA (OVER-HEATING)
CAUSING SEVERE INJURY, BURNS, OR WELTS.**



15. Watchdog Protection: **DO NOT ENTER SPA!** Hi-limit temperature is above acceptable limits. Your spa is deactivated. Remove spa cover to speed cooling. Contact your authorized dealer or service organization.

Note: The heater icon  will be blinking and the error icon  will be displayed under the temperature.





**WARNING: RISK OF HYPERTHERMIA (OVER-HEATING)
CAUSING SEVERE INJURY, BURNS, OR WELTS.**

16. Watchdog Freeze Protection: Spa water is below 4.4°C/40°F. Jet pumps operate until the spa is out of danger. Contact your authorized dealer or service organization.

Note: The heater icon  will be blinking and the error icon  will be displayed under the temperature.

17. Controller Overheat Protection: Controller temperature has exceeded acceptable limits. If condition persists, provide shade for equipment side of spa. Contact your authorized dealer or service organization.

Note: The heater icon  will be blinking and the error icon  will be displayed under the temperature.

18. Panel Com Error: The topside controller is having trouble communicating to your spa. Contact your authorized dealer or service organization.

19. Stereo Com Error (not applicable): The stereo is having trouble communicating to your spa. Contact your authorized dealer or service organization.

20. Wi-Fi Com Error: The Wi-Fi module is having trouble communicating to your spa. Contact your authorized dealer or service organization. Not applicable if the optional SmartTub® system is installed.

21. ClearRay® UV Replacement Reminder: This message will appear when the ClearRay® UV bulb reminder time has expired (Figure 15.0c). The ClearRay® UV bulb **must be replaced**.

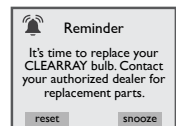

Figure 15.0c

J-LX Export

22. ProClarity/ProClear Filter Reminder: This message will appear when the filter reminder time has expired (Figure 15.0d). Remove the ProClarity/Proclear filters and filter/debris bag for cleaning or replacement.

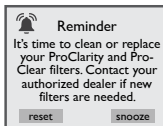

Figure 15.0d

23. ProClarity Depth Filter Reminder (not applicable): This message will appear when the filter reminder time has expired (Figure 15.0e). The ProClarity Depth filter must be replaced.

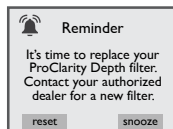

Figure 15.0e

24. Water Refresh Reminder: This message will appear when the “Water Refresh” timer has expired (Figure 15.0f). The water needs to be drained and refilled with fresh water.

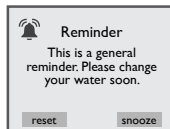



Figure 15.0f

25. Extended Temperature Activated: The spa is set to go up to 40°C (104°F), but it can be set to reach 41°C (106°F). To access the extended temperature you need press and hold your finger over the temperature reading for about 5 seconds. The temperature reading will start to blink to indicate the system is ready. Tap  to raise the temperature up to 41°C (106°F).

Note: The heater icon  will be blinking to indicate that the feature is active.



WARNING: RISK OF HYPERTHERMIA (OVER-HEATING) CAUSING SEVERE INJURY, BURNS, WELTS OR DEATH!

Water temperature in excess of 40°C (104°F) may be injurious to your health.

16.0 Troubleshooting Procedures

In the unlikely event your spa is not working the way you believe it should, please first review all the installation and operating instructions in this manual and check the message on the panel display; second, if you are still not satisfied it is working properly, please follow the appropriate troubleshooting instructions.

PROBLEM	PROCEDURE
NONE OF THE COMPONENTS OPERATE (i.e. pump light)	Check the control panel lights. 1. If there are letters or symbols displayed on the screen, refer to the previous Section 15.0 to determine the meaning and action required. 2. If nothing appears on the screen: A. Check the household circuit breaker. B. Contact you dealer or authorized service center.
PUMP DOES NOT OPERATE	Activate the "JETS": 1. If no sound is detected or if a "buzzing" sound is detected, turn off power to the spa and contact your dealer or service center. 2. If motor operates but no water flows to jets: A. Pump may not be properly primed. See instructions below. B. Contact dealer or authorized service center.
AIR LOCK	Purge "air lock" from circulation pump intake by removing filter cartridge. Hold your garden hose over the filter cartridge wall fitting while using a rag as a seal around hose end. Ask a helper to turn on water for 30 seconds, then turn off. Reinstall filter cartridge and check spa.

Pump Priming Instructions:

1. Turn off power to the spa.
2. Remove the handle from the massage selector supplied by the pump you are priming.
3. Loosen the massage selector's cap slightly (counterclockwise), listening for the air to seep out.
4. Tighten the cap finger-tight, replace the handle and turn the hot tub's power back on.

Note: This method must be used for the jet's pumps because these pumps are not connected to the main filter system in any way.

CAUTION: If freezing conditions exist and pump is not operational, take measures to protect the system from freeze damage. See Section 13.9 titled "Winterizing" (page 48).

J-LX Export

- POOR JET ACTION**
1. Make certain the jets pump is turned on.
 2. Check position of massage selectors.
 3. Open air control for selected jet system.
 4. Check for adequate water level.
 5. Check for dirty filter (page 41).
- WATER IS TOO HOT**
1. Reduce thermostat setting.
 2. Switch hot tub to “Econo” mode to turn heater on only during pre-programmed time (page 33).
 3. Make sure the pumps are turned off and not constantly running.
- NO HEAT**
1. Check thermostat setting.
 2. Keep the cover in place while heating.
 3. If heater indicator is displayed, but no temperature increase is experienced after a reasonable period of time, contact your dealer or authorized service center.
- FILTER/CIRCULATION PUMP OFF**
1. Verify filter/circulation pump is programmed to run (page 32).
 2. Make sure there are no errors preventing the pump from turning on.
 3. Hot tub water is warmer than 95°F (34°C) and 2°F (1°C) warmer than the set temperature. The “Summer Logic” safety feature has activated. See note on page 33 for details.

Jacuzzi builds the best spas in the industry. Nonetheless, we are always striving to improve the quality and features of our products. Your input as a Jacuzzi spa owner is a cherished part of this process. If you have any comments or suggestions, or if you wish to be informed on any new products for your spa, please write to us.

CONGRATULATIONS on your good taste and welcome to the happiest and most relaxed family in the world!

17.0 Circuit Board Diagrams

17.1 Export Models (50 Hz)

This wiring diagram is used for all Export 230 VAC 50 Hz spa models.

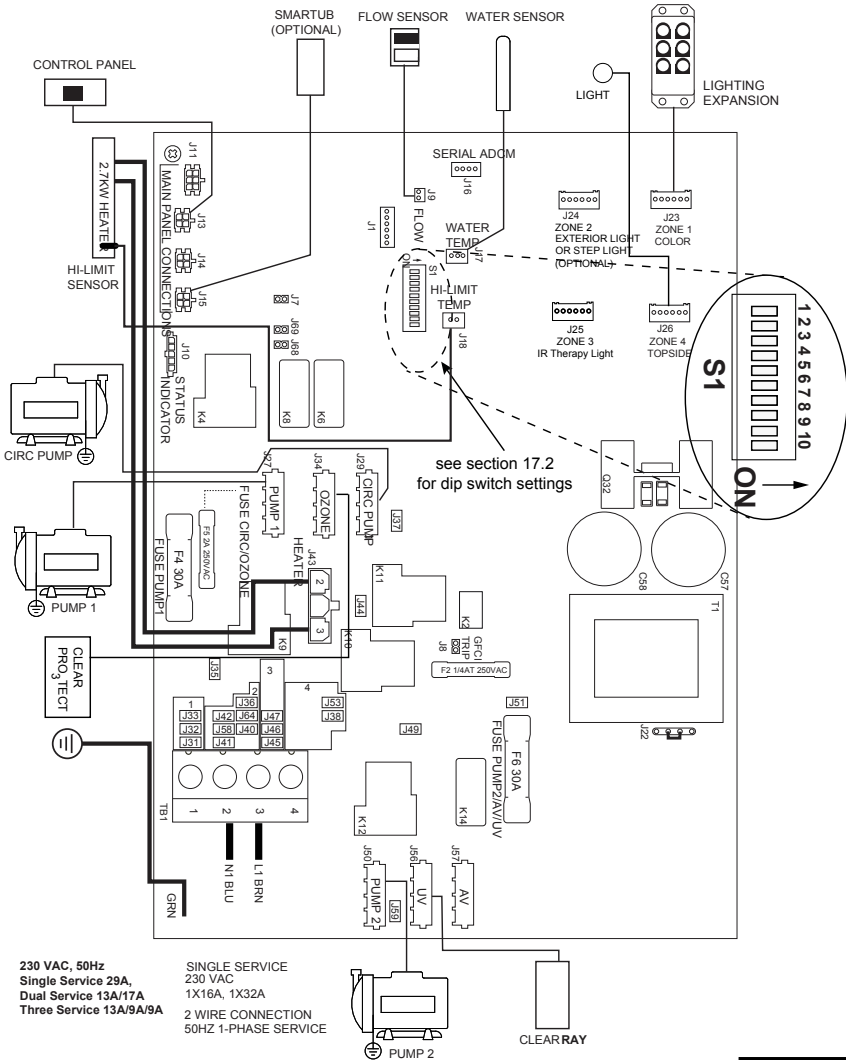

⚠ DANGER
 RISK OF SHOCK OR
 ELECTROCUTION!

Turn power off
 before servicing. This
 task should only be
 performed by a qual-
 ified technician.

J-LX Export

17.2 Dip Switch Settings

A. The dip switches are at the S1 location on the board

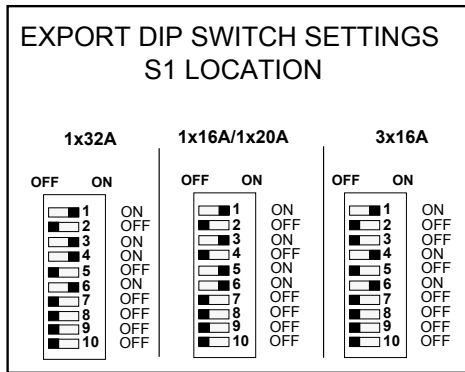
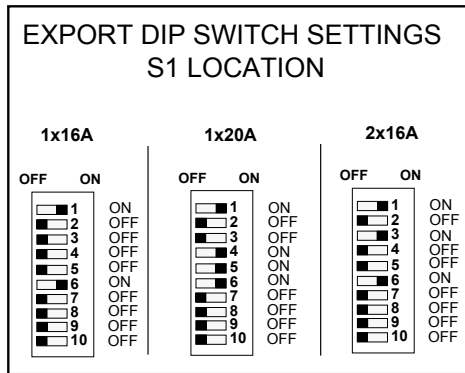

BREAKER	DIP SWITCH NUMBER									
	1	2	3	4	5	6	7	8	9	10
1x16A	ON	OFF	OFF	OFF	OFF	ON	OFF	OFF	OFF	OFF
1x20A	ON	OFF	OFF	ON	ON	ON	OFF	OFF	OFF	OFF
2x16A	ON	OFF	ON	OFF	OFF	ON	OFF	OFF	OFF	OFF
1x32A*	ON	OFF	ON	ON	OFF	ON	OFF	OFF	OFF	OFF
1x16A/1x20A	ON	OFF	ON	OFF	ON	ON	OFF	OFF	OFF	OFF
3x16A	ON	OFF	OFF	ON	OFF	ON	OFF	OFF	OFF	OFF
*1x32A is the factory default setting										
Dip Switch #6 must be on for the IR Light Therapy.										

B. Configuration settings

Single Service (default setting):

- 1x16A This setting will turn the heater off any time the pump is activated.
- 1x20A This setting will turn the heater off any time either one of the pumps are activated (two pump models).
- 1x32A Both pumps and the heater will be allowed to operate at the same time.

Dual Service:

- 2x16A This parameter allows the heating element to operate when the pump is activated.
- 1x16A/1x20A This setting will allow the heater to operate when one or two pumps are running.

Three Phase Service:

- 3x16A This setting is for all two pump model spas. Both pumps and the heater will be allowed to operate at the same time.

J-LX Export

17.3 Single Service 50Hz Connection

Wiring for export models with a single service breaker. The jumper wiring is shown below. The White wire (1*) **must** be installed. **This is the factory default.**

Single Service Jumper Wiring		
Wire	From	To
1*	J33	J47
2	J37	J36
3	J46	J51
4	J59	J41

*Installed white wire at these jumpers

BREAKER TERMINAL CONNECTIONS

L1 = All Components

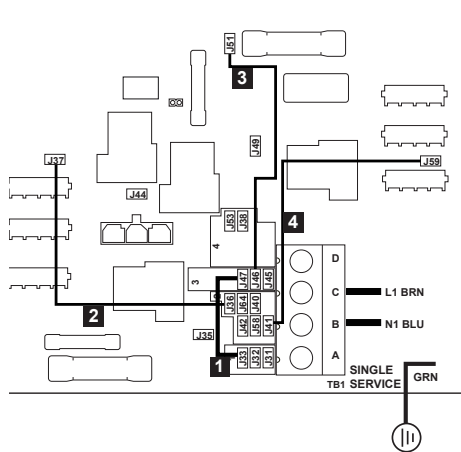

17.4 Dual Service 50Hz Connection

Wiring for export models with dual service breakers. The jumper wiring is shown below.

Dual Service Jumper Wiring		
Wire	From	To
remove jumper at J33-J47		
1	J33	J51
2	J37	J53
3	J59	J38

BREAKER TERMINAL CONNECTIONS

L1 = Heater and transformer

L2 = All other components

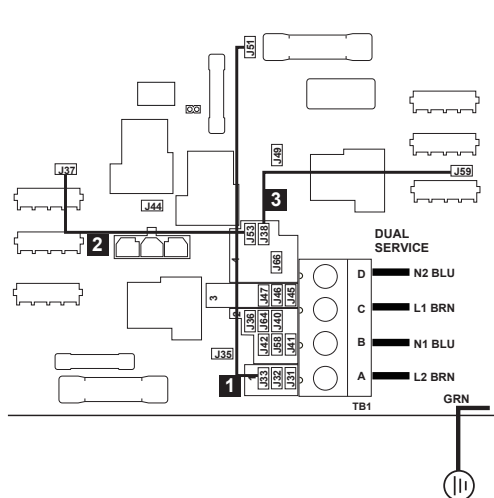

17.5 Three Service 50Hz Connection

Wiring for export models with three service breakers. The jumper wiring is shown below.

Three Service Jumper Wiring		
Wire	From	To
remove jumper at J33-J47		
1	J37	J36
2	J53	J51
3	J59	J41

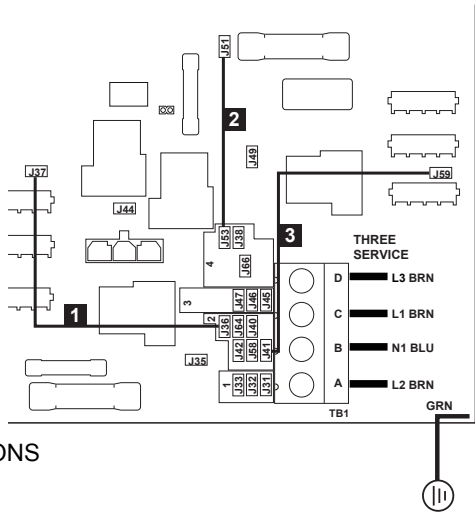

BREAKER TERMINAL CONNECTIONS

- L1 = Heater and transformer
- L2 = Pump 1 and other components
- L3 = Pump 2, Stereo and ClearRay

